

Manivelas

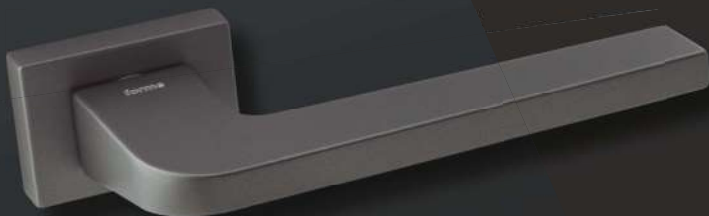

Penta

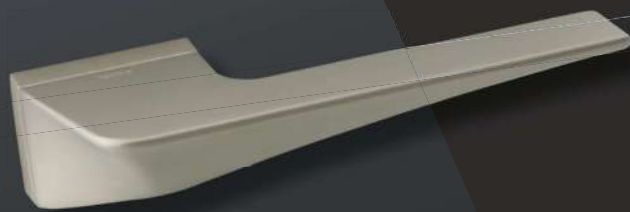
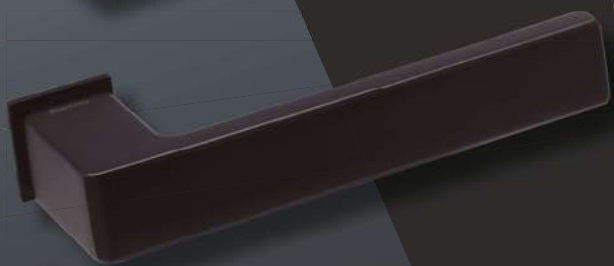
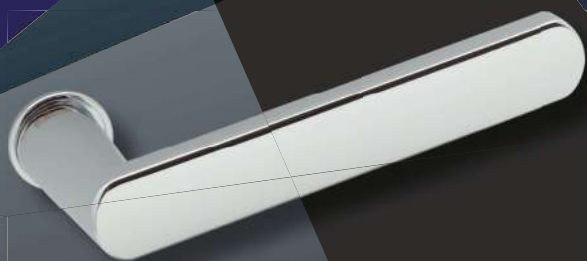

3000.10.12



3000.10.28

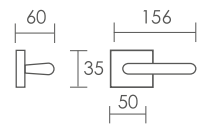

REFERENCIA CONCEPTO
3000.10 Juego de manivelas con roseta / *Complete lever set with rosette*

ACABADOS / *FINISHES*
Níquel Perla (12) · Grafito (28)

Icon

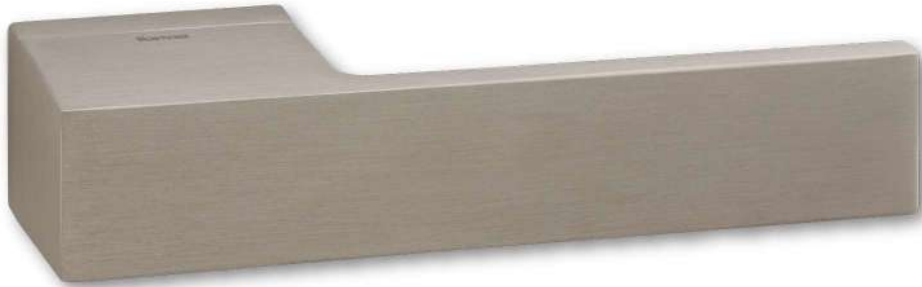

2950.10.12



2950.10.34

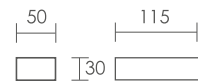

REFERENCIA CONCEPTO
2950.10 Juego de manivelas con roseta / *Complete lever set with rosette*

ACABADOS / FINISHES
Níquel Perla (12) · Negro Mate (34)

Minimal Solis



2121.10.03

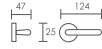

2121.10.12



2121.10.34

REFERENCIA 2121.10
CONCEPTO Juego de manivelas con roseta minimalista Ø25 mm / Complete lever set with minimal rosette Ø25 mm

ACABADOS / FINISHES Cromo Brillo (03) · Níquel Perla (12) · Negro Mate (34)

Minimal Asti



2541.10.12



2541.10.34

REFERENCIA 2541.10
CONCEPTO Juego de manivelas con roseta minimalista 25x25 mm / Complete lever set with minimal rosette 25x25 mm

ACABADOS / FINISHES Níquel Perla (12) · Negro Mate (34)

London



3001.10.12

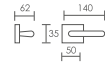

3001.10.28



3001.10.34

REFERENCIA 3001.10
CONCEPTO Juego de manivelas con roseta / Complete lever set with rosette
3001.17 Grisán / Dreh Kipp

ACABADOS / FINISHES Níquel Perla (12) · Grafito (28) · Negro Mate (34)

Elle

3003.10.28

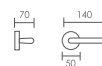

3003.10.34



REFERENCIA 3003.10
CONCEPTO Juego de manivelas con roseta / Complete lever set with rosette
3003.17 Grisán / Dreh Kipp

ACABADOS / FINISHES Grafito (28) · Negro mate (34)

Naxos



2150.10.30



2150.10.09

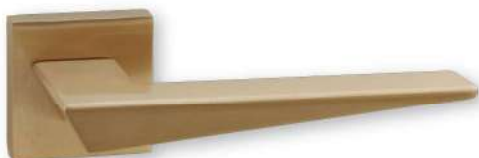

2150.10.12



2150.10.16



2150.10.28



2150.10.34



2150.17.16

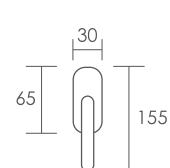

| REFERENCIA | CONCEPTO |
|------------|--|
| 2150.10 | Juego de manivelas con roseta cuadrada / <i>Complete lever set with square rosette</i> |
| 2150.17 | Grisán / <i>Dreh Kipp</i> |

ACABADOS / FINISHES

Latón Satinado (09) · Níquel Perla (12) · Cuero Yester (16) · Grafito (28)
Peltro (30) · Negro Mate (34)

Olimpia



2800.10.12



2800.10.28

2800.10.30

2800.17.12



REFERENCIA CONCEPTO
2800.10 Juego de manivelas con roseta redonda / Complete lever set with round rosette
2800.17 Grisán / Dreh Kipp

ACABADOS / FINISHES
Níquel Perla (12) - Grafito (28) - Peltro (30)

Time



2400.10.34



2400.10.12

2400.10.28

2400.17.28



REFERENCIA CONCEPTO
2400.10 Juego de manivelas con roseta redonda / Complete lever set with round rosette
2400.17 Grisán / Dreh Kipp

ACABADOS / FINISHES
Níquel Perla (12) - Grafito (28) - Negro Mate (34)

Lorena



1360.10.28

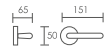

1360.10.12

1360.10.30

1360.17.12



REFERENCIA CONCEPTO
1360.10 Juego de manivelas con roseta redonda / Complete lever set with round rosette
1360.17 Grisán / Dreh Kipp

ACABADOS / FINISHES
Níquel Perla (12) - Grafito (28) - Peltro (30)

Lorena Due



1370.10.30



1370.10.12

1370.10.28

1360.17.28

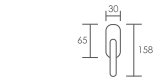

REFERENCIA CONCEPTO
1370.10 Juego de manivelas con roseta cuadrada / Complete lever set with square rosette
1370.17 Grisán / Dreh Kipp

ACABADOS / FINISHES
Níquel Perla (12) - Grafito (28) - Peltro (30)

Asti



2540.10.09

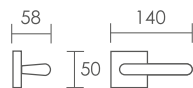

2540.10.12



2540.01.16



2540.10.26



2540.10.34



2540.01.34

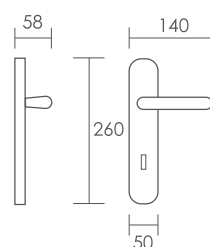

2540.17.34

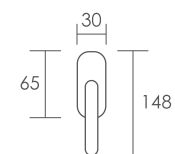

| REFERENCIA | CONCEPTO |
|------------|--|
| 2540.10 | Juego de manivelas con roseta / <i>Complete lever set with rosette</i> |
| 2540.17 | <i>Grisán / Dreh Kipp</i> |

ACABADOS / FINISHES

Latón Sat. (09) · Níquel Perla (12) · Cuero Yester (16) · Blanco Mate (26) · Negro Mate (34)

| REFERENCIA | CONCEPTO |
|------------|---|
| 2540.01 | Juego de manivelas con placa / <i>Complete lever set with plate</i> |

ACABADOS / FINISHES

Níquel Perla (12) · Negro Mate (34)

Solis

2120.10.28

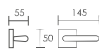

2120.10.03



2120.10.12



2120.17.03

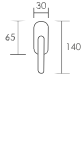

2120.10.26



2120.10.30



| REFERENCIA | CONCEPTO |
|------------|---|
| 2120.10 | Juego de manivelas con roseta / Complete lever set with rosette |
| 2120.17 | Grisán / Dreh Kipp |

ACABADOS / FINISHES

Cromo Brillo (03) - Níquel Perla (12) - Blanco Mate (26) - Grafito (28) - Peltro (30)

Quadrata



3540.10.04

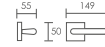

3540.10.34



3540.15



3540.14



8005.02.34

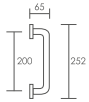

| REFERENCIA | CONCEPTO |
|------------|--|
| 3540.10 | Juego manivelas con roseta quadrata / Complete lever set with rosette Quadrata |
| 3540.14 | Roseta Quadrata c/b viro / Rosette Quadrata with key hole yale |
| 3540.15 | Juego rosetas Quadrata con condensa y desbloqueo / Set rosette Quadrata with locking knob release and emergency button |
| 8005.02 | Manillón con roseta / Pull handle with rosettes |

ACABADOS / FINISHES

Níquel Satinado (04) - Negro Mate (34)

Asti

MANILLONES



2540.02.09

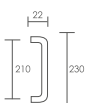

2540.02.03



2540.02.12



2540.02.16



2540.02.28



2540.02.30



2540.02.34

| REFERENCIA | CONCEPTO |
|------------|--|
| 2540.02 | Manillón sin rosetas de 210 mm. / Pull handle 210 mm. without rosettes |

ACABADOS / FINISHES

Cromo Brillo (03) - Latón Satinado (09) - Níquel Perla (12) - Cuero Yester (16) - Blanco Mate (26) - Grafito (28) - Peltro (30) - Negro Mate (34)

Martina

MANILLONES



1400.02.03



1400.02.09



1400.02.12



1400.02.28



1400.02.30



1400.02.34



1400.02.16

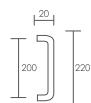

| REFERENCIA | CONCEPTO |
|------------|--|
| 1400.02 | Manillón sin rosetas de 200 mm. / Pull handle 200 mm. without rosettes |

ACABADOS / FINISHES

Cromo Brillo (03) - Latón Satinado (09) - Níquel Perla (12) - Cuero Yester (16) - Grafito (28) - Peltro (30) - Negro Mate (34)

Condenas

CON ROSETA CUADRADA



2540.15.09 2540.15.12 2540.15.16



2540.15.28 2540.15.30 2540.15.34



Condenas

CON ROSETA REDONDA



2400.15.12 2400.15.28 2400.15.30 2400.15.34



REFERENCIA 2540.15 CONCEPTO Juego roseta cuadrada 50x50 mm. con condena y desbloqueo
Set square rosettes 50x50 mm. with locking knob release and emergency button

ACABADOS / FINISHES

Latón Satinado (09) · Níquel Perla (12) · Cuero Yester (16) · Blanco Mate (26) · Grafito (28) · Peltro (30) · Negro Mate (34)

2400.15 Juego roseta redonda \varnothing 50 mm. con condena y desbloqueo
Set round rosettes \varnothing 50 mm. with locking knob release and emergency button

ACABADOS / FINISHES

Cromo Brillo (03) · Níquel Perla (12) · Blanco Mate (26) · Grafito (28) · Peltro (30) · Negro Mate (34)

Condenas

CON ROSETA RECTANGULAR 50X35

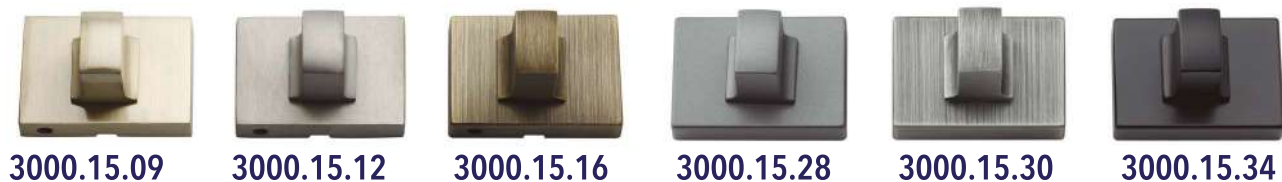

REFERENCIA
3000.15

CONCEPTO
Juego roseta rectangular 50x35 mm. con condena y desbloqueo
Set rosettes 50x35 mm. with locking knob release and emergency button

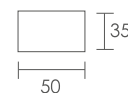

ACABADOS / FINISHES

Latón Satinado (09) · Níquel Perla (12) · Cuero Yester (16) · Grafito (28) · Peltro (30)
Negro Mate (34)

Condenas

CON ROSETA MINIMAL REDONDA



2121.15.03

2121.15.12

2121.15.34



REFERENCIA
2121.15

CONCEPTO
Juego roseta minimal con condena y desbloqueo
Set minimal rosettes with locking knob release and emergency button

ACABADOS / FINISHES

Cromo Brillo (03) · Níquel Perla (12) · Negro Mate (34)

Condenas

CON ROSETA MINIMAL CUADRADA



2541.15.12



2541.15.34



REFERENCIA
2541.15

CONCEPTO
Juego roseta minimal con condena y desbloqueo
Set minimal rosettes with locking knob release and emergency button

ACABADOS / FINISHES

Níquel Perla (12) · Negro Mate (34)

Roseta cuadrada

c/b viro



2540.14.09 2540.14.12 2540.14.16



2540.14.28 2540.14.30 2540.14.34



Roseta redonda

c/b viro

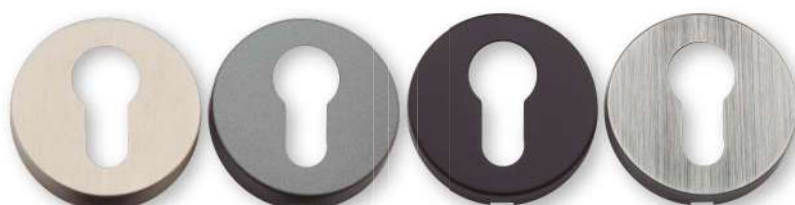

2400.14.12 2400.14.28 2400.14.34 2400.14.30



REFERENCIA CONCEPTO
2540.14 Roseta cuadrada c/b viro / *Square rosette with key hole yale*

ACABADOS / FINISHES
Latón Satinado (09) · Níquel Perla (12) · Cuero Yester (16) · Blanco Mate (26)
Grafito (28) · Peltro (30) · Negro Mate (34)

2400.14 Roseta redonda c/b viro / *Round rosette with key hole yale*

ACABADOS / FINISHES
Cromo Brillo (03) · Níquel Perla (12) · Blanco Mate (26) · Grafito (28) · Peltro (30) · Negro Mate (34)

Roseta rectangular

50x35 c/b viro

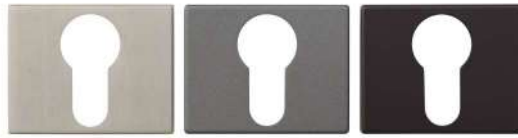

3000.14.12 **3000.14.28** **3000.14.34**

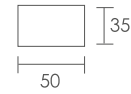

REFERENCIA 3000.14
CONCEPTO Roseta rectangular 50x35 mm. c/b viro
Rectangular rosette with key hole yale

ACABADOS / FINISHES

Níquel Perla (12) · Grafito (28) · Negro Mate (34)

Roseta minimal

ovalada c/b viro



2121.14.03 **2121.14.12** **2121.14.34**



REFERENCIA 2121.14
CONCEPTO Roseta minimalista c/b viro
Minimal rosette with key hole yale

ACABADOS / FINISHES

Cromo Brillo (03) · Níquel Perla (12) · Negro Mate (34)

Roseta minimal

rectangular c/b viro



2541.14.12 **2541.14.34**

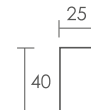

REFERENCIA 2541.14
CONCEPTO Roseta minimal c/b viro
Rectangular rosette with key hole yale

ACABADOS / FINISHES

Níquel Perla (12) · Negro Mate (34)

Sorolla



8008.10.03



8008.01.04

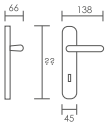

8008.10.25



8005.02.25

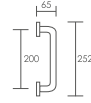

REFERENCIA CONCEPTO
8008.01 Juego manivelas con placa / Complete lever set with plate

ACABADOS / FINISHES
Cromo Brillo (03) - Níquel Satinado (04)

8008.10 Juego manivelas con roseta cuadrada / Complete lever set on square rosette
8005.02 Manillón con rosetas / Pull handle with rosettes

ACABADOS / FINISHES
Cromo Brillo (03) - Níquel Brillo / Satinado (25)

Brescia



8005.10.25

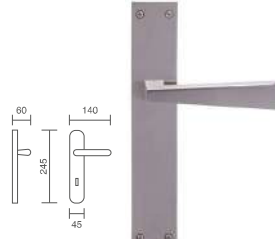

8005.01.04

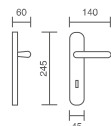

8005.02.25

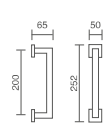

referencia

8005.10 Juego manivelas con roseta / Complete lever set with rosette.
8005.02 Manillón con rosetas / Pull handle with rosettes.

acabados / finishes Níquel Brillo / Níquel Satinado

referencia

8005.01 Juego manivelas con placa / Complete lever set with plate.

acabados / finishes Níquel Satinado

Torino



2990.10.04



2990.01

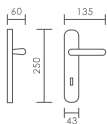

2990.10.08



2990.10.08

referencia

2990.01 Juego de manivelas con placa / Complete lever set with plate.
2990.10 Juego de manivelas con roseta / Complete lever set with rosettes.

acabados / finishes

Niq. Sat. (04) - Cromo Sat. (08) - Níquel Perla (12)

Gaudí

8007.10.25

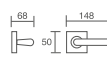

8007.10.02



8007.01.25

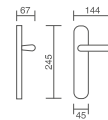

referencia

8007.01 Juego Manivelas con placa / Complete lever with plate

acabados / finishes

Níquel Brillo / Níquel Sat. (25)

referencia

8007.10 Juego Manivelas con roseta / Complete lever with rosette

acabados / finishes

Pulido Sat. (02) - Níquel Brillo / Níquel Sat. (25)

Quadrata



3540.10.04
55 149
50



3540.10.34



3540.15



3540.14



8005.02.34

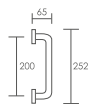

| | |
|--|--|
| REFERENCIA | CONCEPTO |
| 3540.10 | Juego manivelas con roseta quadrata / Complete lever set with rosette Quadrata |
| 3540.14 | Roseta Quadrata c/b viro / Rosette Quadrata with key hole yale |
| 3540.15 | Juego rosetas Quadrata con condensa y desbloqueo / Set rosette Quadrata with locking knob release and emergency button |
| 8005.02 | Manillón con roseta / Pull handle with rosettes |
| ACABADOS / FINISHES | |
| Níquel Satinado (04) - Negro Mate (34) | |

Oslo



8017.10.04

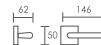

8017.10.34

| | |
|--|---|
| REFERENCIA | CONCEPTO |
| 8017.10 | Juego de manivelas con roseta / Complete lever set with rosette |
| ACABADOS / FINISHES | |
| Níquel Satinado (04) - Negro Mate (34) | |

Xúquer



8010.10.25

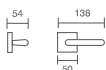

8010.02.25

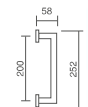

8003.05.04



8003.03.04



8010.01.25

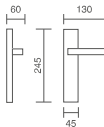

| | |
|--------------------------------------|---|
| REFERENCIA | CONCEPTO |
| 8010.01 | Juego de manivelas con placa / Complete lever set with plate |
| 8010.10 | Juego de manivelas con roseta / Complete lever set with rosette |
| 8010.02 | Manillón con rosetas / Pull handle with rosettes |
| ACABADOS / FINISHES | |
| Níquel Brillo / Níquel Satinado (25) | |

| | |
|------------|--|
| REFERENCIA | CONCEPTO |
| 8003.03 | Tirador de maletero / Wardrobe pull on small plate |
| 8003.05 | Tirador de armario / Wardrobe pull on plate |

ACABADOS / FINISHES
Níquel Satinado (04)

Xúquer Roseta Redonda



8020.10.25



8010.01.25



8020.02.25



| | |
|------------|--|
| referencia | concepto |
| 8020.10 | Juego manivelas con roseta redonda / Complete lever set with a round rosette |
| 8020.02 | Manillón con rosetas / Pull handle with rosettes |
| 8010.01 | Juego manivelas con placa / Complete lever set with plate |
| 8010.17 | Grisón Dk / Dreh Kipp |

acabados / finishes
Níquel Brillo - Níquel Satinado (25)

Turia

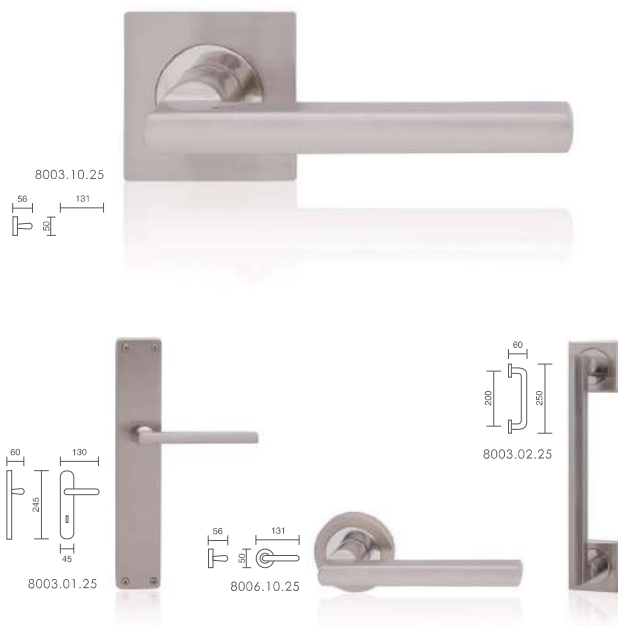

referencia

- 8003.01 Juego manivelas con placa / Complete lever set with plate.
- 8003.10 Juego manivelas con roseta cuadrada / Complete lever set with square rosette.
- 8003.02 Manillón con rosetas cuadradas / Pull handle with square rosettes.
- 8006.10 Juego manivelas con roseta redonda / Complete lever set with round rosette.
- 8003.25 Manillón con rosetas redondas / Pull handle with rosettes.

acabados / finishes

Níquel Brillo / Níquel Satinado

Trento



referencia

- 8004.01 Juego manivelas con placa / Complete lever set with plate
- 8004.10 Juego manivelas con roseta / Complete lever set with rosette
- 8005.02 Manillón con rosetas / Pull handle with rosettes

acabados / finishes

Níquel Satinado (04) - Pulido Satinado (02) - Cuero (05)

Zurich



referencia

- 8016.10 Juego Manivelas con roseta / Complete lever with rosette
- 8016.02 Manillón con Roseta / Pull handle with rosettes

acabados / finishes

Cromo Brillo / Cromo Sat. (07) - Níquel Brillo / Níquel Sat. (25)

Morella



referencia

- 8014.01 Juego Manivelas con placa / Complete lever with plate
- 8014.22 Manillón con placa / Pull handle with plate
- 8014.10 Juego Manivelas con roseta / Complete lever with rosette

acabados / finishes

Pulido Sat. (02) - Níquel Sat. (04) - Cuero (05)

Carmen



6300.10.04



6300.10.16

6300.01.09

referencia

6300.10 Juego manivelas con roseta / Complete lever set with rosette.
6300.01 Juego manivelas con placa / Complete lever set with plate.

acabados / finishes

Pulido Satinado - Níquel Satinado - Cuero Yester

Ninfa



3470.10.02

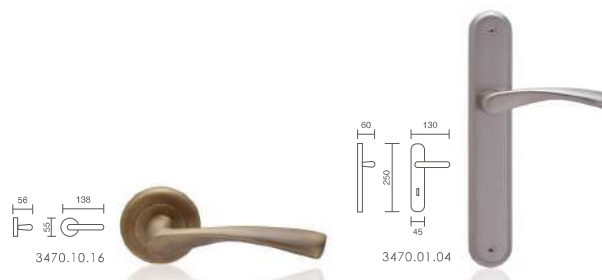

3470.10.16

3470.01.04

referencia

3470.10 Juego manivelas con roseta / Complete lever set with rosette.

acabados / finishes

Pulido Satinado - Níquel Satinado - Cuero Yester

Verona



8015.10.03



8015.02.04



8015.10.04

referencia

8015.10 Juego de manivelas con roseta / Complete lever set with rosette.
8015.02 Manillón con rosetas redondas / Pull handel with rosettes.

acabados / finishes

Cromo brillo (03) - Níquel satinado (04) /

Manivela Roseta ø 70

8010.70.25

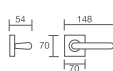

8002.70.02

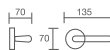

8002.70.25



referencia

8010.70 Juego Manivelas con roseta 70x70 mm./ Complete lever with rosette 70x70 mm.

acabados / finishes

Níquel Brillo / Níquel Sat. (25)

referencia

8002.70 Juego Manivelas con roseta Ø 70 mm./ Complete lever with rosette Ø 70 mm.

acabados / finishes

Pulido Sat. (02) - Níquel Brillo / Níquel Sat. (25)

Bernia



8002.10



8002.01

70
50
125

8002.10

referencia

8002.01 Juego manivelas con placa / Complete lever set with plate.
8002.10 Juego manivelas con roseta / Complete lever set with rosette.

acabados / finishes

Pulido Satinado - Niquel Brillo / Niquel Satinado

Mariola



8001.10.25

70
50
125

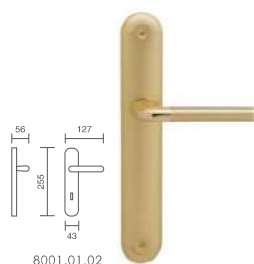

8001.01.02

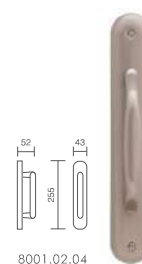

8001.02.04

referencia

8001.01 Juego manivelas con placa / Complete lever set with plate.
8001.10 Juego manivelas con roseta / Complete lever set with rosette.

acabados / finishes

Pulido Satinado - Niquel Brillo / Niquel Satinado

referencia

8001.02 Manillón con placa / Pull handle with plate.

acabados / finishes

Niquel Satinado (04) - Cuero Yester (16) - Latón Sat. (09)

Montgó



8012.10.25



8012.10.02

8012.10.05

8012.01.04

referencia

8012.01 Juego manivelas con placa / Complete lever set with plate.
8012.10 Juego manivelas con roseta / Complete lever set with rosette.

acabados / finishes

Pulido Satinado - Niquel Brillo / Niquel Satinado - Cuero

referencia

8012.02 Manillón con rosetas / Pull handle with rosettes.

acabados / finishes

Pulido B. - Pulido Sat. - Niquel Sat. - Cromo Sat. - Cuero
Niquel Brillo - Niquel Satinado

Mirage



2300.01.09



2300.01.16



2300.01.01



2300.01.04

65
220
140
60

referencia

2300.01 Juego manivelas con placa ancha / Complete lever set with wide plate

acabados / finishes

Pulido brillo (01) - Niquel satinado (04) - Latón satinado (09) - Cuero yester (16)
Polish brass - Satin nickel - Matt brass - Cuero Yester

Altea



8011.01.02

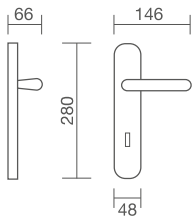

8011.01.04



8011.01.05



8014.22.04

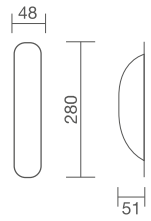

8011.10.02

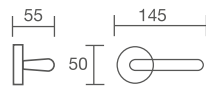

8011.10.04

| REFERENCIA | CONCEPTO |
|------------|--|
| 8014.01 | Juego de manivelas con placa / <i>Complete lever set with plate</i> |
| 8014.22 | Manillón con placa / <i>Pull handle with plate</i> |
| 8014.10 | Juego de manivelas con roseta / <i>Complete lever set with rosette</i> |

ACABADOS / FINISHES

Pulido Sat. (02) · Níquel Sat. (04) · Cuero (05)

Alhambra



| referencia | |
|------------|--|
| 4600.01 | Juego manivelas con placa / Complete lever set with plate. |
| 4600.02 | Manillón con placa / Pull handle with plate. |
| 4400.03 | Tirador maletero / Wardrobe pull on small plate. |
| 4400.05 | Tirador armario / Wardrobe pull on plate. |

acabados / finishes
 Pulido Satinado (02) - Cuero (05)

Marbella



| referencia | |
|------------|--|
| 4500.01 | Juego manivelas con placa / Complete lever set with plate. |
| 4400.02 | Manillón con placa / Pull handle with plate. |
| 4400.03 | Tirador maletero / Wardrobe pull on small plate. |
| 4400.05 | Tirador armario / Wardrobe pull on plate. |

acabados / finishes
 Pulido Satinado - Cuero

Valencia



| referencia | |
|------------|--|
| 1010.01 | Juego manivelas con placa / Complete lever set with plate. |
| 1010.02 | Manillón con placa / Pull handle with plate. |
| 4400.03 | Tirador maletero / Wardrobe pull on small plate. |
| 4400.05 | Tirador armario / Wardrobe pull on plate. |

acabados / finishes
 Pulido Satinado

Aitana



| referencia | |
|------------|--|
| 4400.01 | Juego manivelas con placa / Complete lever set with plate. |
| 4400.02 | Manillón con placa / Pull handle with plate. |
| 4400.03 | Tirador maletero / Wardrobe pull on small plate. |
| 4400.05 | Tirador armario / Wardrobe pull on plate. |

acabados / finishes
 Pulido Satinado (02) - Níquel Satinado (04) - Cuero (05) - PVD (18)

Ronda



4650.01.02



4600.02.02

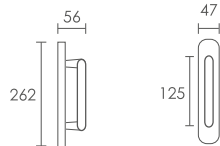

4650.01.05

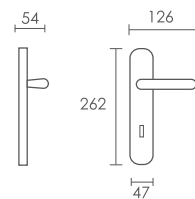

referencia

4650.01 Juego manivelas con placa / Complete lever set with plate

4600.02 Manillón con placa / Pull handle with plate

4400.03 Tirador maletero / Wardrobe pull on small plate

4400.05 Tirador armario / Wardrobe pull on plate

acabados / finishes

Pulido satinado (02) - Cuero (05) / Polish brass finish - Leather finish

Florenzia



3600.01.02

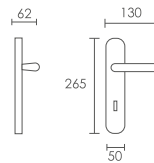

3600.01.05



3600.02.02

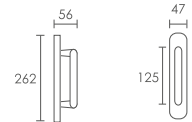

referencia

| | |
|---------|---|
| 3600.01 | Juego manivelas con placa / Complete lever set with plate |
| 3600.02 | Manillón con placa / Pull handle with plate |
| 3600.03 | Tirador maletero / Wardrobe pull on small plate |
| 3600.05 | Tirador armario / Wardrobe pull on plate |

acabados / finishes

Pulido satinado (02) - Cuero (05) / Polish brass finish - Leather finish

Tuareg



referencia

- 2850.01 Juego de manivelas con placa / Complete lever set with plate.
- 2850.10 Juego de manivelas con roseta / Complete lever set with rosette.
- 2850.02 Manillón con rosetas / Pull handle with rosettes.
- 2850.17 Grisán / Dreh Kipp

acabados / finishes

Anticato (10) - Cuero Yester (16) - Peltro (30) - Negro Mate (34)

Q-800

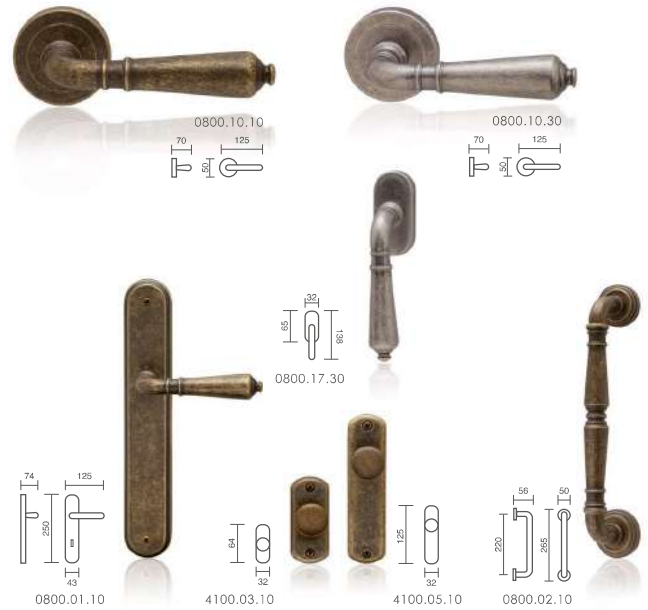

referencia

- 0800.01 Juego manivelas con placa / Complete lever set with plate.
- 0800.10 Juego manivelas con roseta / Complete lever set with rosette.
- 0800.02 Manillón con rosetas / Pull handle with rosettes.
- 0800.17 Grisán / Dreh kipp.
- 0800.21 Juego manivelas con placa estrecha / Complete lever set on narrow plate.
- 4100.03 Tirador maletero / Wardrobe pull on small plate.
- 4100.05 Tirador armario / Wardrobe pull on plate.

acabados / finishes

Anticato (10) - Peltro (30)

4003 Champan Anticato

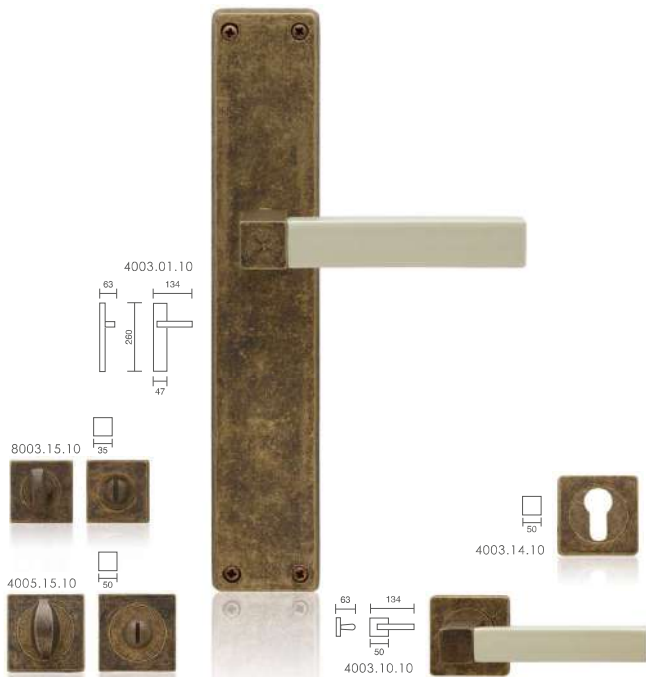

referencia

- 4003.01.10 Juego manivelas con placa / Complete lever set with plate.
- 4003.10.10 Juego manivelas con roseta / Complete lever set with rosette.
- 4003.02.10 Manillón con rosetas / Pull handle with rosettes.
- 4003.17.10 Grisán / Dreh kipp.
- 8003.03.10 Tirador maletero / Wardrobe pull on small plate.
- 8003.05.10 Tirador armario / Wardrobe pull on plate.

4003 Champan Cuero

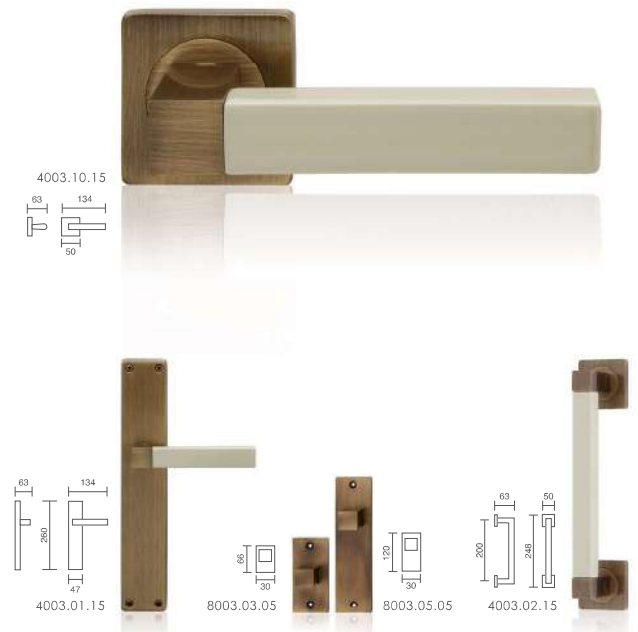

referencia

- 4003.01.15 Juego manivelas con placa / Complete lever set with plate.
- 4003.10.15 Juego manivelas con roseta / Complete lever set with rosette.
- 4003.02.15 Manillón con rosetas / Pull handle with rosettes.
- 4003.17.15 Grisán / Dreh kipp.
- 8003.03.05 Tirador maletero / Wardrobe pull on small plate.
- 8003.05.05 Tirador armario / Wardrobe pull on plate.

4000 Porcelana Blanca Pulido Brillo



referencia

- 4000.01.01 Juego de manivelas con placa / Complete lever set with plate.
- 4000.10.01 Juego de manivelas con roseta / Complete lever set with rosette.
- 4000.02.01 Manillón con rosetas / Pull handle with rosettes.
- 4000.17.01 Grisán / Dreh Kipp
- 4000.03.01 Tirador de maletero / Wardrobe pull on small plate.
- 4000.05.01 Tirador de armario / Wardrobe pull on plate.

4000 Porcelana Blanca Níquel Sat.



referencia

- 4000.01.04 Juego de manivelas con placa / Complete lever set with plate.
- 4000.10.04 Juego de manivelas con roseta / Complete lever set with rosette.
- 4000.02.04 Manillón con rosetas / Pull handle with rosettes.
- 4000.17.04 Grisán / Dreh Kipp
- 4000.03.04 Tirador de maletero / Wardrobe pull on small plate.
- 4000.05.04 Tirador de armario / Wardrobe pull on plate.

4000 Porcelana Blanca Cuero

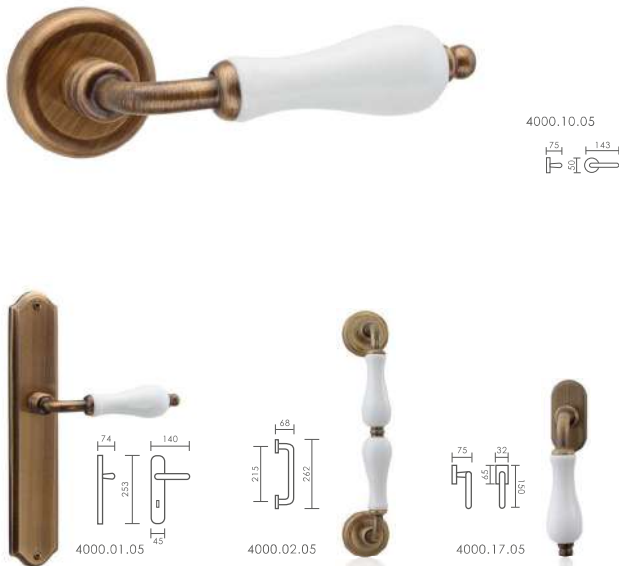

referencia

- 4000.01.05 Juego de manivelas con placa / Complete lever set with plate.
- 4000.10.05 Juego de manivelas con roseta / Complete lever set with rosette.
- 4000.02.05 Manillón con rosetas / Pull handle with rosettes.
- 4000.17.05 Grisán / Dreh Kipp
- 4000.03.05 Tirador de maletero / Wardrobe pull on small plate.
- 4000.05.05 Tirador de armario / Wardrobe pull on plate.

4000 Porcelana Blanca Peltro

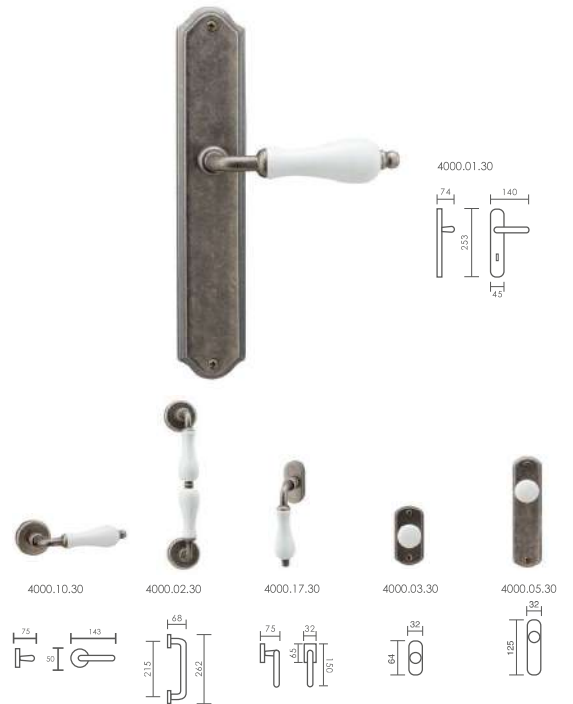

referencia

- 4000.01.30 Juego manivelas con placa / Complete lever set with plate
- 4000.10.30 Juego manivelas con roseta / Complete lever set with rosette
- 4000.02.30 Manillón con rosetas / Pull handle with rosettes
- 4000.17.30 Grisán Dk / Dreh Kipp
- 4000.03.30 Tirador de maletero / Wardrobe pull on small plate
- 4000.05.30 Tirador de armario / Wardrobe pull on plate

4000 Porcelana Champan Anticato

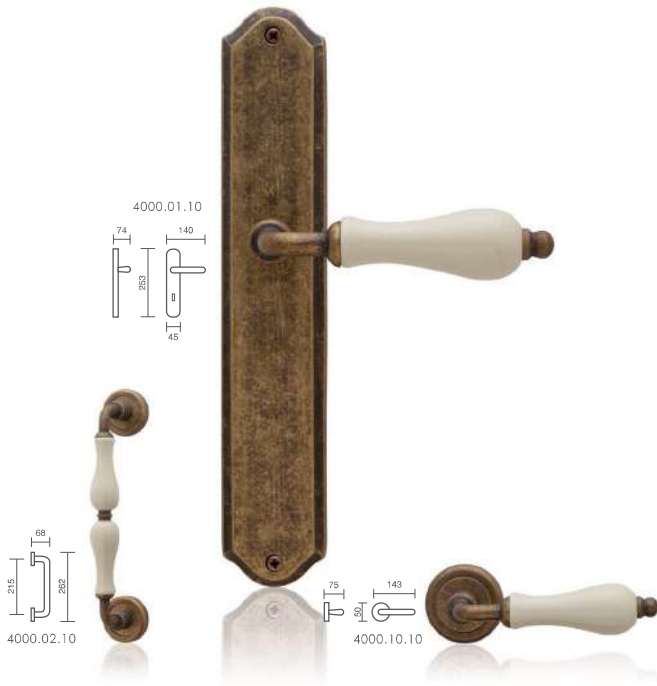

referencia

- 4000.01.10 Juego manivelas con placa / Complete lever set with plate.
- 4000.10.10 Juego manivelas con roseta / Complete lever set with rosette.
- 4000.02.10 Manillón con rosetas / Pull handle with rosettes.
- 4000.17.10 Grisán / Dreh kipp.
- 4000.21.10 Juego manivelas con placa estrecha / Complete lever set on narrow plate.
- 4000.03.10 Tirador maletero / Wardrobe pull on small plate.
- 4000.05.10 Tirador armario / Wardrobe pull on plate.

4000 Porcelana Champan Cuero



referencia

- 4000.01.15 Juego manivelas con placa / Complete lever set with plate.
- 4000.10.15 Juego manivelas con roseta / Complete lever set with rosette.
- 4000.02.15 Manillón con rosetas / Pull handle with rosettes.
- 4000.17.15 Grisán / Dreh kipp.
- 4000.03.15 Tirador maletero / Wardrobe pull on small plate.
- 4000.05.15 Tirador armario / Wardrobe pull on plate.

4000 Porcelana Craquele Anticato

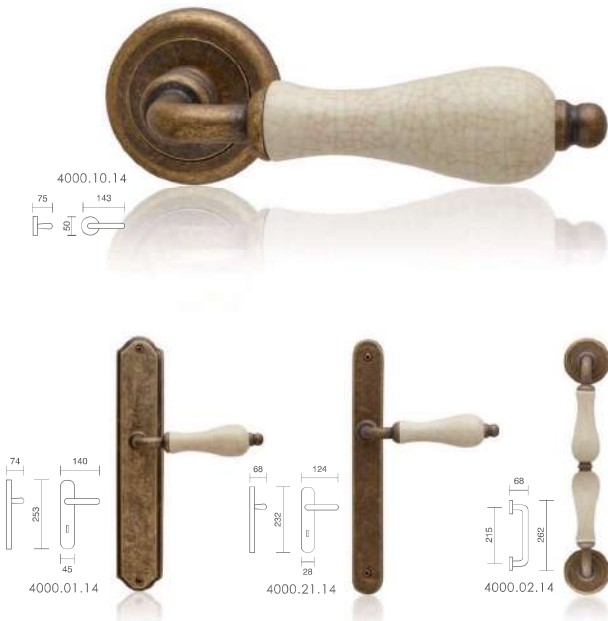

referencia

- 4000.01.14 Juego manivelas con placa / Complete lever set with plate.
- 4000.10.14 Juego manivelas con roseta / Complete lever set with rosette.
- 4000.02.14 Manillón con rosetas / Pull handle with rosettes.
- 4000.17.14 Grisán / Dreh kipp.
- 4000.21.14 Juego manivelas con placa estrecha / Complete lever set on narrow plate.
- 4000.03.14 Tirador maletero / Wardrobe pull on small plate.
- 4000.05.14 Tirador armario / Wardrobe pull on plate.

4000 Porcelana Craquele Cuero

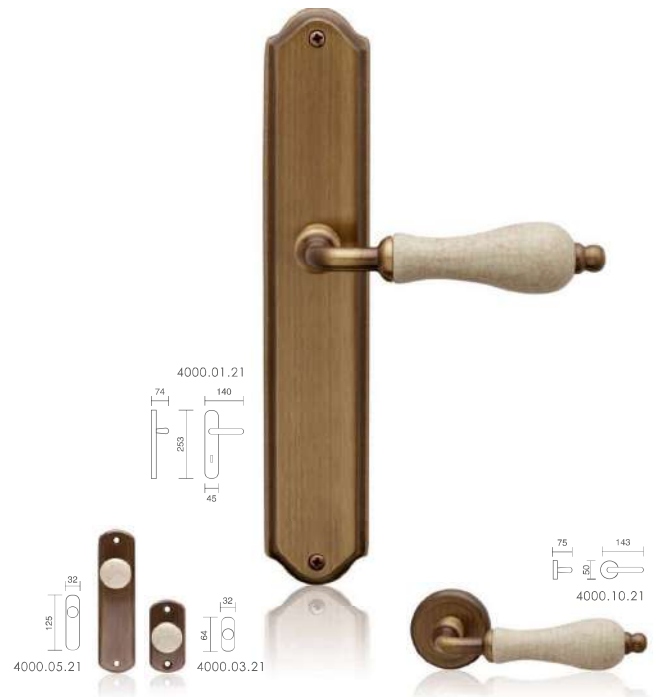

referencia

- 4000.01.21 Juego manivelas con placa / Complete lever set with plate.
- 4000.10.21 Juego manivelas con roseta / Complete lever set with rosette.
- 4000.02.21 Manillón con rosetas / Pull handle with rosettes.
- 4000.17.21 Grisán / Dreh kipp.
- 4000.03.21 Tirador maletero / Wardrobe pull on small plate.
- 4000.05.21 Tirador armario / Wardrobe pull on plate.

Manivelas de placa estrecha



referencia

- 4100.21 Juego manivelas con placa estrecha sin muelle / Complete lever set on narrow plate without spring
- 4100.31 Juego manivelas con placa estrecha con muelle / Complete lever set on narrow plate with spring

acabados / finishes

Pulido Brillo (01) - Níquel Satinado (04) - Negro Mate (34)

Manivelas de polymida



referencia

- 2001.01 Juego de manivelas con placa / Complete lever set with plate.
- 2001.10 Juego de manivelas con roseta / Complete lever set with rosette.
- 2001.02 Manillón con rosetas de 150mm. / Pull handle 150mm. with rosettes.
- 2001.25 Manillón con rosetas de 240mm. / Pull handle 240mm. with rosettes.
- 2001.14 Roseta de 50mm. c/b Viro / Key hole yale on rosette Ø 50mm.
- 2001.15 Juego rosetas Ø 50mm. con condena y desbloqueo / Set rosettes Ø 50mm. with locking knob release and emergency button.
- 0530.00.35 Condena y desbloqueo para manivela con placa / Locking knob release and emergency button for handle on plate.

acabados / finishes

Polymida negro (35), Polymida blanco (26)

Manivelas de aluminio



9002.10.25 - bernia



9003.10.25 - turia

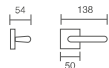

9012.10.25 - monigó



referencia

- 9002.10 Juego manivelas con roseta / Complete lever set with rosette.
- 9003.10 Juego manivelas con roseta cuadrada / Complete lever set with square rosette.
- 9012.10 Juego manivelas con roseta / Complete lever set with rosette.

acabados / finishes

Níquel Brillo / Níquel Satinado



Acero Inoxidable

7001

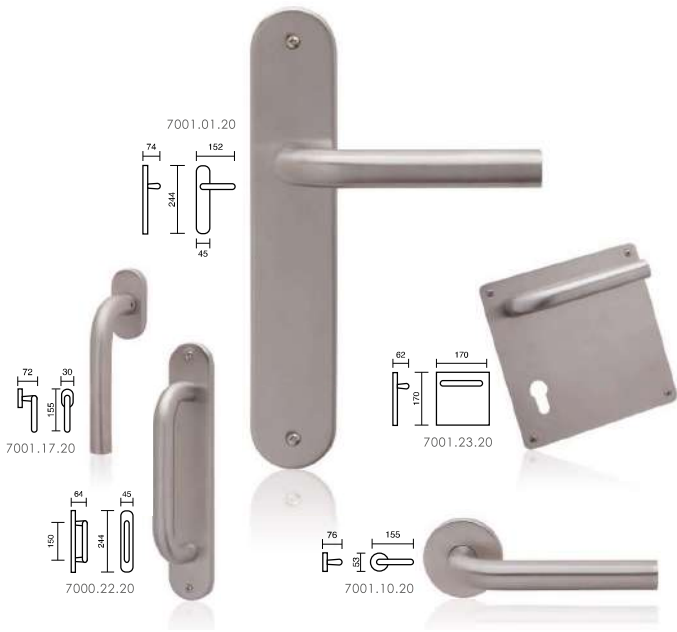

referencia

- 7001.01.20 Juego manivelas con placa / Complete lever set with plate.
- 7001.10.20 Juego manivelas con roseta / Complete lever set with rosette.
- 7001.17.20 Grísán / Dreh kipp.
- 7001.21.20 Juego manivelas con placa estrecha sin muelle / Complete lever set on narrow plate without spring
- 7001.23.20 Juego manivelas con placa de 170x170mm. / Complete lever set on plate 170x170mm.
- 7000.22.20 Manillón con placa / Pull handle with plate.
- 7001.31.20 Juego manivelas con placa estrecha con muelle / Complete lever set on narrow plate with spring

7002

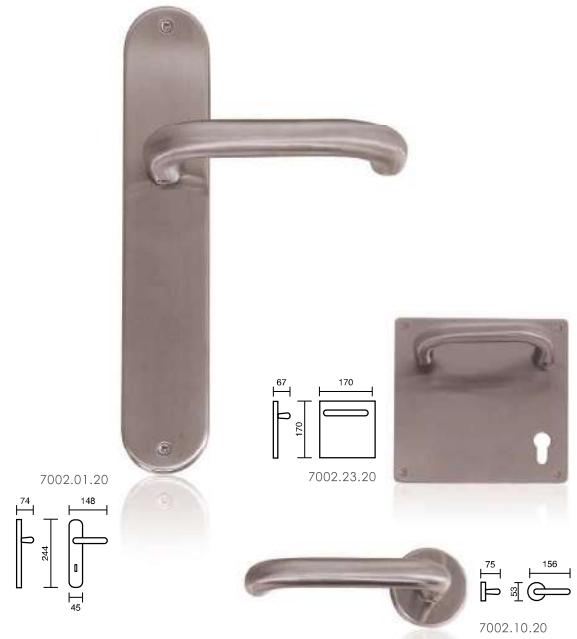

referencia

- 7002.01.20 Juego manivelas con placa / Complete lever set with plate.
- 7002.10.20 Juego manivelas con roseta / Complete lever set with rosette.
- 7002.23.20 Juego manivelas con placa de 170x170mm. / Complete lever set on plate 170x170mm.
- 7002.41.20 Juego manivelas con placa rectangular 245x50 mm. / Complete lever set with square plate.

7003



referencia

- 7003.01.20 Juego manivelas con placa / Complete lever set with plate.
- 7003.10.20 Juego manivelas con roseta / Complete lever set with rosette.
- 7003.17.20 Grísán / Dreh kipp.
- 7003.21.20 Juego manivelas con placa estrecha sin muelle / Complete lever set on narrow plate without spring
- 7003.02.20 Manillón de 200mm. con rosetas / Pull handle 200mm. on rosettes.

7004



referencia

- 7004.01.20 Juego manivelas con placa / Complete lever set with plate.
- 7004.10.20 Juego manivelas con roseta / Complete lever set with rosette.
- 7004.17.20 Grísán / Dreh kipp.

Modelo 7003 negro



7003.10.34

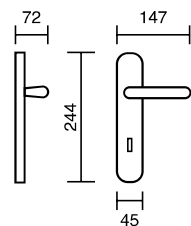
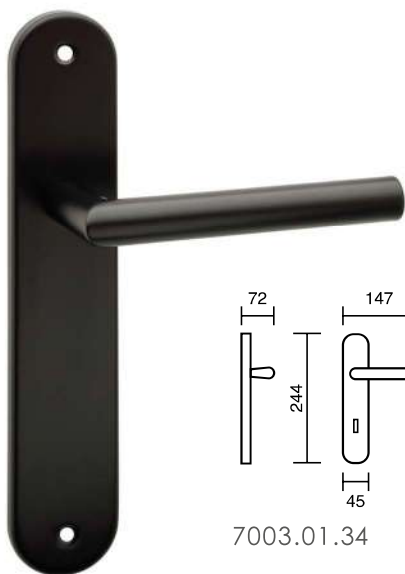
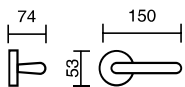

7003.01.34

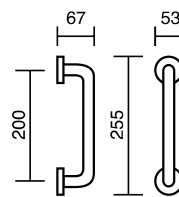

7003.02.34

referencia

- | | |
|---------|--|
| 7003.01 | Juego manivelas con placa / Complete lever set with plate. |
| 7003.10 | Juego manivelas con roseta / Complete lever set with rosette. |
| 7003.02 | Manillón de 200mm. con rosetas / Pull handle 200mm. on rosettes. |

acabados / finishes

Negro Mate (34)

Venecia

7001.10.25



referencia

| | |
|---------|---|
| 7001.10 | Juego manivelas con roseta/ Complete lever set with rosette |
| 7000.02 | Manillón con roseta/ Pull handle with rosette |
| 7005.15 | Juego Rosetas ø 53mm. con condena y desbloqueo / Set rosettes ø 53 mm. with locking knob release and emergency button |

acabados / finishes

Acero Inox./ Acero Brillo (25)

7006



7006.10.20



referencia

Acero Inox./ Acero Brillo (25)

Bari

7004.10.25



referencia

| | |
|---------|---|
| 7004.10 | Juego manivelas con roseta/ Complete lever set with rosette |
| 7004.02 | Manillón 200 mm. con roseta/ Pull handle 200 mm. with rosette |
| 7005.15 | Juego Rosetas ø 53mm. con condena y desbloqueo / Set rosettes ø 53 mm. with locking knob release and emergency button |

acabados / finishes

Acero Inox./ Acero Brillo (25)

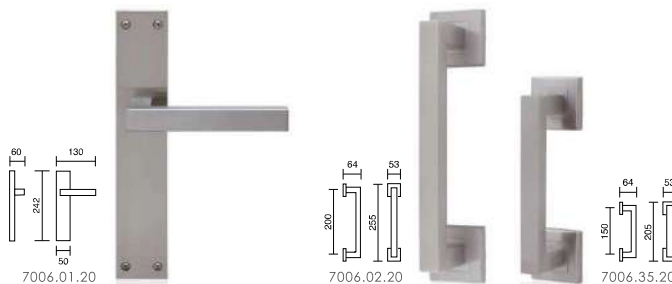

referencia

| | |
|------------|--|
| 7006.01.20 | Juego manivelas con placa / Complete lever set with plate. |
| 7006.10.20 | Juego manivelas con roseta / Complete lever set with rosette. |
| 7006.02.20 | Manillón de 200mm. con rosetas / Pull handle 200mm. on rosettes. |
| 7006.35.20 | Manillón de 150mm. con rosetas / Pull handle 150mm. on rosettes. |

Munich

NUEVO SISTEMA DE MONTAJE MAGNÉTICO



7008.10.20



referencia

| | |
|---------|--|
| 7008.01 | Juego manivelas con placa plana / Complete lever set with flat plate |
| 7008.10 | Juego manivelas con roseta plana y nuevo sistema de montaje magnético / Complete lever set with flat rosettes. |
| 7008.02 | Juego de manillones de 200 mm. con rosetas planas / Set pull handles 200 mm. with flat rosettes. |
| 7008.14 | Juego rosetas planas ø53mm c/b viro / Set flat rosettes ø53 mm. with key hole type yale |
| 7008.15 | Juego rosetas planas ø53mm con condena y desbloqueo / Set flat rosettes ø53 mm. with locking knob release and emergency button |
| 7008.17 | Grísán / Dreh kipp |

7011 Favara

7011.10.20



referencia

| | |
|------------|---|
| 7011.01.20 | Juego manivelas con placa / Complete lever set with plate. |
| 7011.10.20 | Juego manivelas con roseta / Complete lever set with rosette. |
| 7011.17.20 | Grísán / Dreh kipp. |

Turín



7007.01.34

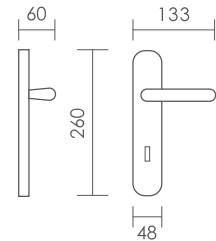

7007.10.20



7007.10.34

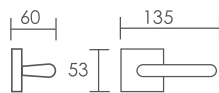

referencia

| | |
|---------|---|
| 7007.01 | Juego manivelas con placa/ <i>Complete lever set with plate</i> |
| 7007.10 | Juego manivelas con roseta/ <i>Complete lever set with rosette</i> |
| 7007.02 | Manillón con rosetas cuadradas/ <i>Pull handle 200 mm. with square rosettes</i> |
| 7007.17 | Grisán / <i>Dreh kipp</i> |

acabados / finishes

Acero Inoxidable (20) · Negro Mate (34)

Rovella



| referencia | |
|------------|---|
| 7012.01.20 | Juego manivelas con placa / Complete lever set with plate. |
| 7012.02.20 | Manillón con rosetas / Pull handle with rosettes. |
| 7012.10.20 | Juego manivelas con roseta / Complete lever set with rosette. |
| 7012.17.20 | Grisán / Dreh kipp. |

Quart



| referencia | |
|------------|---|
| 7014.01.20 | Juego manivelas con placa / Complete lever set with plate. |
| 7014.02.20 | Manillón con rosetas / Pull handle with rosettes. |
| 7014.10.20 | Juego manivelas con roseta / Complete lever set with rosette. |
| 7014.17.20 | Grisán / Dreh kipp. |

7024

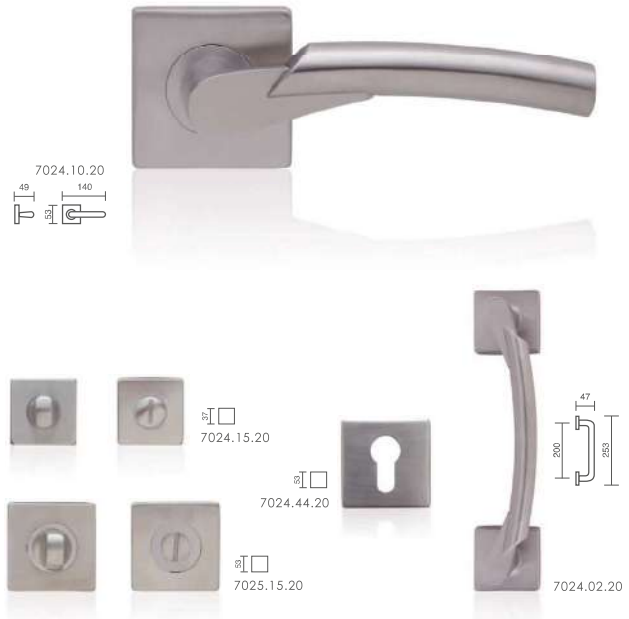

| referencia | |
|------------|--|
| 7024.10.20 | Juego manivelas con roseta cuadrada / Complete lever set with square rosette. |
| 7024.02.20 | Manillón con rosetas cuadradas / Pull handle with square rosettes. |
| 7024.15.20 | Juego rosetas cuadradas ø37mm. con condena y desbloqueo / Set square rosettes ø37mm. with locking knob release and emergency button. |
| 7025.15.20 | Juego rosetas cuadradas ø53mm. con condena y desbloqueo / Set square rosettes ø53mm. with locking knob release and emergency button. |
| 7024.44.20 | Roseta cuadrada c/b viro / Key hole yale on square rosette. |

Manillones 7000.32.20 / 7012.32.20



| referencia | |
|------------|---|
| 7000.32.20 | Juego manillones sin roseta (posibilidad de montar sobre puerta de cristal). Set pull handle without rosettes for glass door. |
| 7012.32.20 | Juego manillones sin roseta (posibilidad de montar sobre puerta de cristal). Set pull handle without rosettes for glass door. |

Manillón Viena

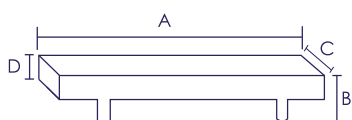

| REFERENCIA | CONCEPTO | A | B | C | D |
|------------|---|-----|----|----|----|
| 7009.L1 | Juego de manillones 12 x 25 x 200 mm. / <i>Set pull handle 200mm.</i> | 200 | 50 | 25 | 12 |
| 7009.L2 | Juego de manillones 12 x 25 x 400 mm. / <i>Set pull handle 400mm.</i> | 400 | 50 | 25 | 12 |
| 7009.L3 | Juego de manillones 12 x 25 x 600 mm. / <i>Set pull handle 600mm.</i> | 600 | 50 | 25 | 12 |
| 7009.U1 | Manillón 12 x 25 x 200 mm. / <i>Pull handle 200 mm.</i> | 200 | 50 | 25 | 12 |
| 7009.U2 | Manillón 12 x 25 x 400 mm. / <i>Pull handle 400 mm.</i> | 400 | 50 | 25 | 12 |
| 7009.U3 | Manillón 12 x 25 x 600 mm. / <i>Pull handle 600 mm.</i> | 600 | 50 | 25 | 12 |

ACABADOS / FINISHES

Acero Inoxidable (20) · Negro Mate (34)

Accesorios Acero Inoxidable

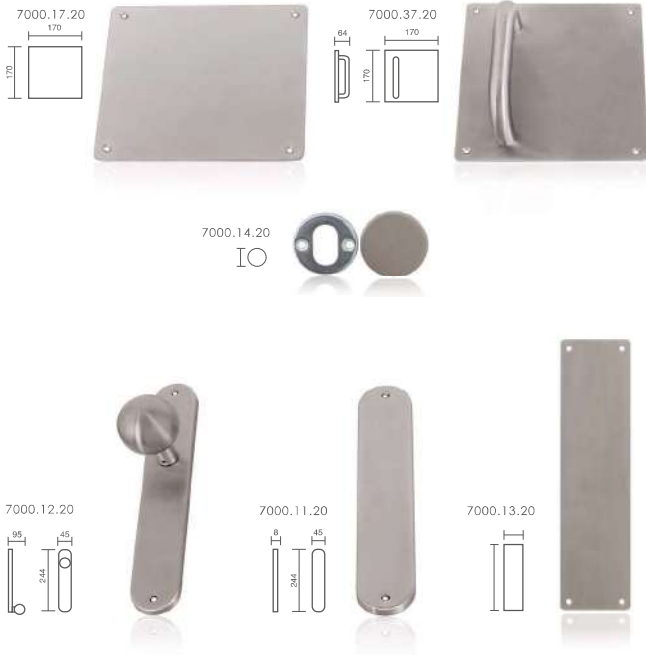

referencia

- 7000.11.20 Placa de limpieza de 244x45x8 / Stainless steel plate 244x45x8.
- 7000.13.20 Placa de limpieza de 300x80mm. / Stainless steel plate 300x80mm.
- 7000.14.20 Roseta ciega de Ø52mm. / Blind rosette Ø52mm.
- 7000.17.20 Placa de limpieza de 170x170x1.5 / Stainless steel plate 170x170x1.5.
- 7000.12.20 Pomo móvil con placa / Door knob on plate stainless steel.
- 7000.37.20 Manillón de 120mm. con placa 170x170x1.5 / Pull handle 120mm. on plate stainless steel.

acabados / finishes:

Acero Inoxidable (20)

Manillón con rosetas

Serie 7000



referencia

- 7000.35.20 Manillón de 150mm. con rosetas / Pull handle 150mm. with rosettes.
- 7000.02.20 Manillón de 200mm. con rosetas / Pull handle 200mm. with rosettes.
- 7000.25.20 Manillón de 250mm. con rosetas / Pull handle 250mm. with rosettes.
- 7000.30.20 Manillón de 300mm. con rosetas / Pull handle 300mm. with rosettes.

Pomos de Puerta



referencia

- 0500.00.20 Pomo de puerta / Door knob.
- 7500.00.20 Pomo de puerta / Door knob.



referencia

- 7515.00 Pomo de puerta / Door knob.
- 7503.00 Pomo cuadrado de puerta / Door knob square shaped.

acabados / finishes:

Acero Inoxidable

Pomos con placa y roseta



referencia

- 7000.12 Pomo móvil con placa / Door knob with spring on plate
- 7000.16 Pomo fijo con placa / Door knob fixed on plate
- 7000.20 Juego de pomos con placa / Complete doors knobs sets with spring on plate
- 7000.43 Pomo fijo con roseta / Door knob fixed on rosette
- 7000.45 Juego de pomos con roseta / Complete doors knobs sets with spring on rosette

Acero inoxidable (20) / Stainless steel

Tiradores de Acero

Serie 7003.50

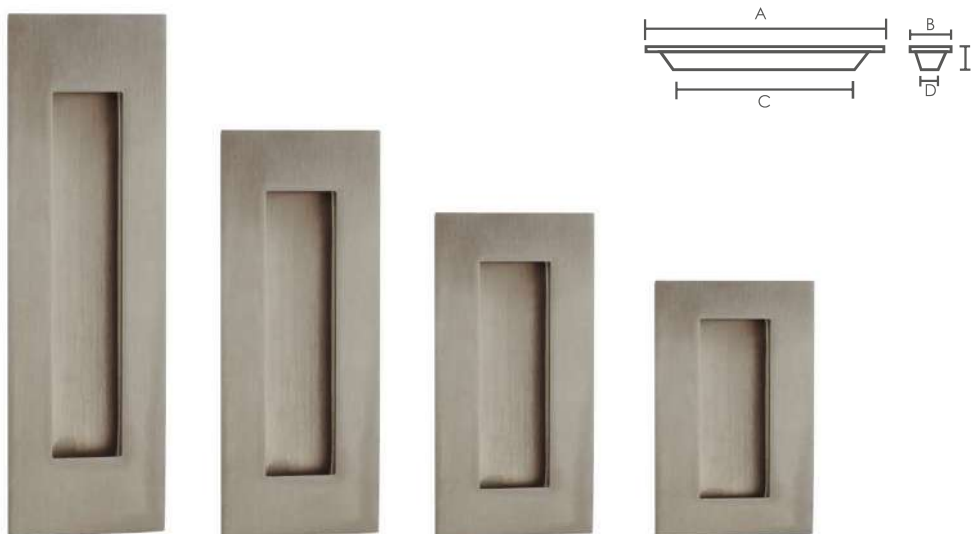
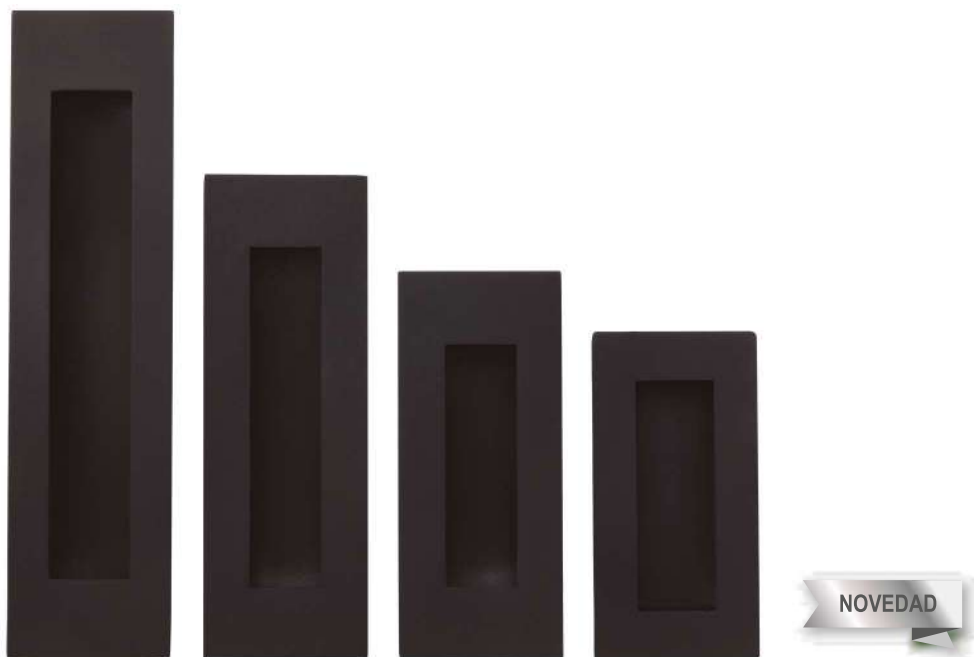

| REFERENCIA | CONCEPTO | A | B | C | D | E |
|------------|--|-----|----|-----|----|----|
| 7003.50.20 | Tirador de 100x50 mm. / Rectangular pull handle 100x50 mm. | 100 | 50 | 82 | 37 | 14 |
| 7003.51.20 | Tirador de 120x50 mm. / Rectangular pull handle 120x50 mm. | 120 | 50 | 95 | 30 | 14 |
| 7003.52.20 | Tirador de 150x50 mm. / Rectangular pull handle 150x50 mm. | 150 | 50 | 125 | 30 | 14 |
| 7003.53.20 | Tirador de 200x50 mm. / Rectangular pull handle 200x50 mm. | 200 | 50 | 175 | 30 | 14 |

ACABADOS / FINISHES

Acero Inoxidable (20) · Negro Mate (34)

Tiradores Serie 7002

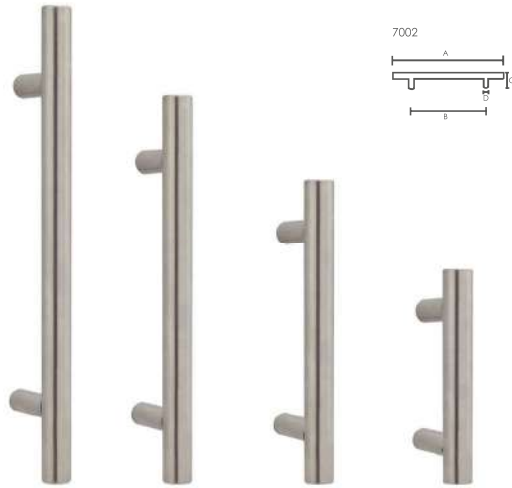

| referencia | | A | B | C | D |
|------------|--|-----|-----|----|----|
| 7002.50.20 | Tirador de 96 mm. / Pull handle 96 mm. | 158 | 96 | 35 | 12 |
| 7002.51.20 | Tirador de 128 mm. / Pull handle 128 mm. | 190 | 128 | 35 | 12 |
| 7002.52.20 | Tirador de 160 mm. / Pull handle 160 mm. | 222 | 160 | 35 | 12 |
| 7002.53.20 | Tirador de 192 mm. / Pull handle 192 mm. | 254 | 192 | 35 | 12 |
| 7002.54.20 | Tirador de 224 mm. / Pull handle 224 mm. | 286 | 224 | 35 | 12 |
| 7002.55.20 | Tirador de 320 mm. / Pull hand 320 mm. | 382 | 320 | 35 | 12 |
| 7002.56.20 | Tirador de 420 mm. / Pull handle 420 mm. | 482 | 420 | 35 | 12 |
| 7002.57.20 | Tirador de 520 mm. / Pull handle 520 mm. | 582 | 520 | 35 | 12 |
| 7002.58.20 | Tirador de 620 mm. / Pull handle 620 mm. | 682 | 620 | 35 | 12 |
| 7002.59.20 | Tirador de 720 mm. / Pull handle 720 mm. | 782 | 720 | 35 | 12 |
| 7002.60.20 | Tirador de 820 mm. / Pull handle 820 mm. | 882 | 820 | 35 | 12 |

acabados / finishes

Acero inoxidable (20) / Stainless steel

Tiradores Serie 7006

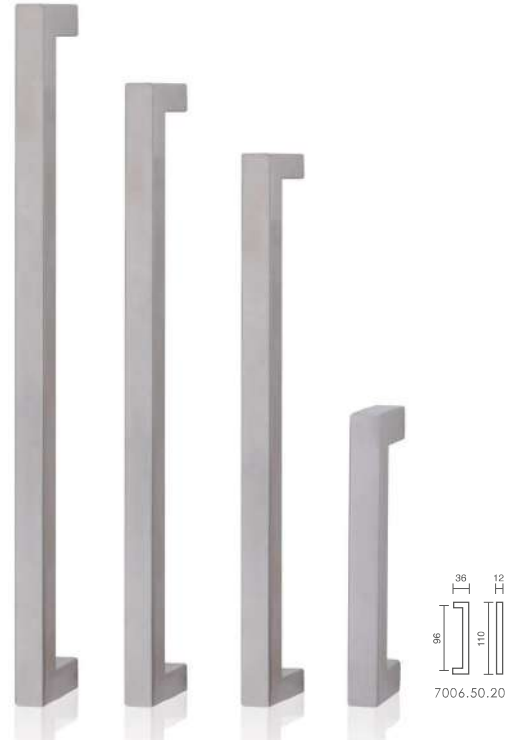

| referencia | | | |
|------------|--|--|--|
|------------|--|--|--|

| | | | |
|------------|--|------------|--|
| 7006.50.20 | Tirador de 96mm. / Pull handle 96mm. | 7006.56.20 | Tirador de 420mm. / Pull handle 420mm. |
| 7006.51.20 | Tirador de 128mm. / Pull handle 128mm. | 7006.57.20 | Tirador de 520mm. / Pull handle 520mm. |
| 7006.52.20 | Tirador de 160mm. / Pull handle 160mm. | 7006.58.20 | Tirador de 620mm. / Pull handle 620mm. |
| 7006.53.20 | Tirador de 192mm. / Pull handle 192mm. | 7006.59.20 | Tirador de 720mm. / Pull handle 720mm. |
| 7006.54.20 | Tirador de 224mm. / Pull handle 224mm. | 7006.60.20 | Tirador de 820mm. / Pull handle 820mm. |
| 7006.55.20 | Tirador de 320mm. / Pull handle 320mm. | | |

Tiradores Serie 7001.50/7001.60/7001.70

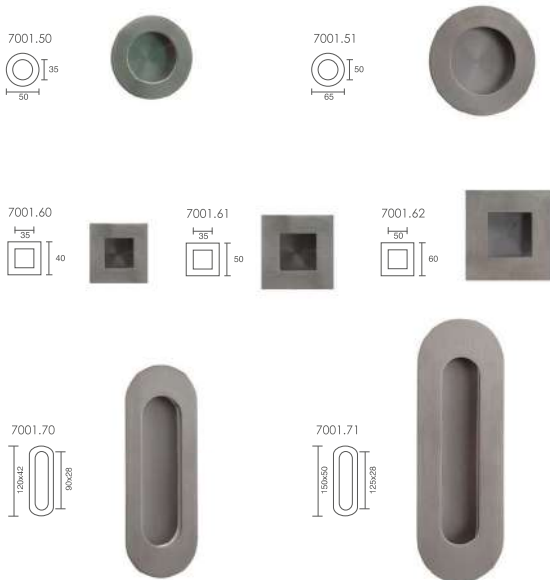

| referencia | | |
|------------|---------------------------|------------------------------|
| 7001.50 | Tirador Redondo ø 50mm. | Round Pull Handle ø50mm. |
| 7001.51 | Tirador Redondo ø 65mm. | Round Pull Handle ø65mm. |
| 7001.60 | Tirador Cuadrado 40x40mm. | Square Pull Handle 40x40 mm. |
| 7001.61 | Tirador Cuadrado 50x50mm. | Square Pull Handle 50x50 mm. |
| 7001.62 | Tirador Cuadrado 60x60mm. | Square Pull Handle 60x60 mm. |
| 7001.70 | Tirador Ovalado 120x42mm. | Oval Pull Handle 120x42mm. |
| 7001.71 | Tirador Ovalado 150x50mm. | Oval Pull Handle 150x50mm. |

acabados / finishes

Acero inoxidable (20) / Stainless steel

Tiradores con Embellecedor

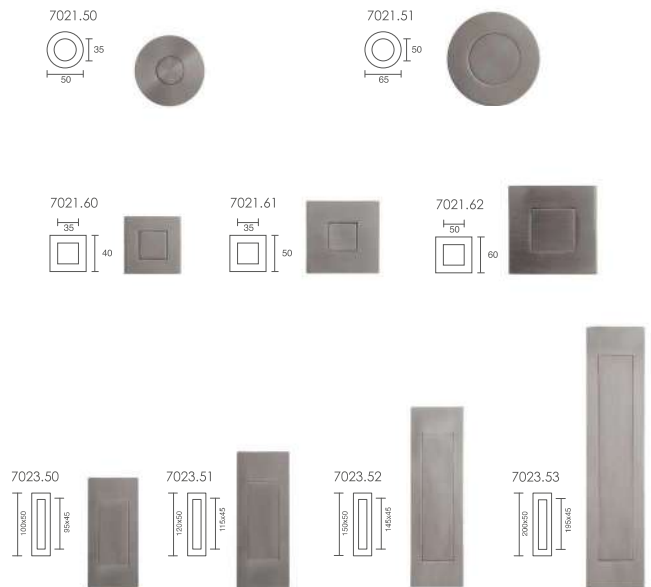

| referencia | | |
|------------|-------------------------------|-----------------------------------|
| 7021.50 | Tirador Redondo ø 50mm. | Round Pull Handle ø50mm. |
| 7021.51 | Tirador Redondo ø 65mm. | Round Pull Handle ø65mm. |
| 7021.60 | Tirador Cuadrado 40x40mm. | Square Pull Handle 40x40 mm. |
| 7021.61 | Tirador Cuadrado 50x50mm. | Square Pull Handle 50x50 mm. |
| 7021.62 | Tirador Cuadrado 60x60mm. | Square Pull Handle 60x60 mm. |
| 7023.50 | Tirador Rectangular 100x50mm. | Rectangular Pull Handle 100x50mm. |
| 7023.51 | Tirador Rectangular 120x50mm. | Rectangular Pull Handle 120x50mm. |
| 7023.52 | Tirador Rectangular 150x50mm. | Rectangular Pull Handle 150x50mm. |
| 7023.53 | Tirador Rectangular 200x50mm. | Rectangular Pull Handle 200x50mm. |

acabados / finishes

Acero inoxidable (20) / Stainless steel

Manivela con placa y roseta estrecha



referencia

- 7001.31 Juego manivelas placa estrecha con muelle / Complete lever set on narrow plate with spring.
7001.33 Juego manivelas roseta ovalada con muelle / Complete lever set on oval rosette with spring.
Acero inoxidable (20) / Stainless steel

Pernios 7901-7902 acero inoxidable

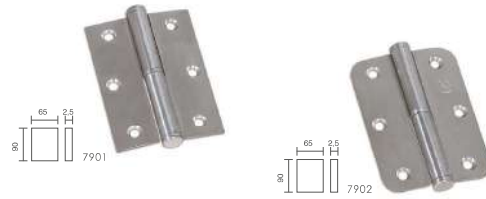

referencia

- 7901.08 Pernio canto recto derecha 90x65x2,5 / Hinge square shaped right hand 90x65x2,5.
7901.09 Pernio canto recto izquierda 90x65x2,5 / Hinge square shaped left hand 90x65x2,5.
7902.08 Pernio canto curvo derecha 90x65x2,5 / Hinge round shaped right hand 90x65x2,5.
7902.09 Pernio canto curvo izquierda 90x65x2,5 / Hinge round shaped left hand 90x65x2,5.

Pernios acero inoxidable

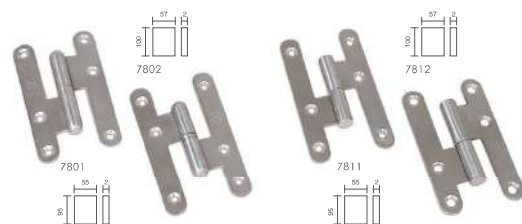

referencia

- 7801.08 Pernio derecha 95x55x2 / Hinge right hand 95x55x2.
7801.09 Pernio izquierda 95x55x2 / Hinge left hand 95x55x2.
7802.08 Pernio derecha 100x57x2 / Hinge right hand 100x57x2.
7802.09 Pernio izquierda 100x57x2 / Hinge left hand 100x57x2.
7811.08 Pernio derecha remate recto 95x55x2 / Hinge right hand with terminal right 95x55x2.
7811.09 Pernio izquierda remate recto 95x55x2 / Hinge left hand with terminal right 95x55x2.
7812.08 Pernio derecha remate recto 100x57x2 / Hinge right hand with terminal right 100x57x2.
7812.09 Pernio izquierda remate recto 100x57x2 / Hinge left hand with terminal right 100x57x2.

Roseta c/b acero inoxidable



referencia

- 7000.14.20 Roseta Redonda ø53 ciega / Rosette ø53 without key hole
7000.24.20 Roseta Redonda ø53 c/b Viro / Rosette ø53 with key hole
7000.34.20 Roseta Redonda ø53 c/b borja / Rosette ø53 with key hole type borja
7000.44.20 Roseta Redonda ø53 c/b viro para cerradura seguridad / Rosette ø53 without key hole for lock security
7024.44.20 Roseta cuadrada 53x53 c/b viro / Square rosette 53x53 with key hole
7850.14.20 Roseta Ovalada 65x30 c/b viro / Oval rosette 65x30 with key hole
0560.00.00 Cuadradillo expansivo 8x8x65 mm. / Stretch out iron 8x8x65 mm.
0560.09.00 Cuadradillo expansivo 8x8x90 mm. / Stretch out iron 8x8x90 mm.

Tiradores y Pomos de Armario

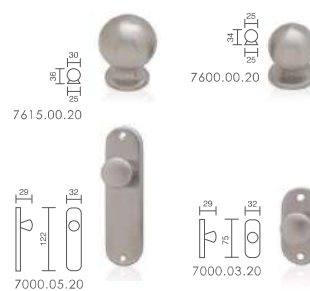

referencia

- 7000.03.20 Tirador de maletero / Wardrobe pull on small plate.
7000.05.20 Tirador de armario / Wardrobe pull on plate.
7600.00.20 Pomo de bola ø25mm. / Small knob ø25mm.
7615.00.20 Pomo de bola ø30mm. / Small knob ø30mm.

Condenas acero inoxidable



referencia

- 7000.15.20 Juego rosetas ø37mm. con condena y desbloqueo / Set rosettes ø37mm. with locking knob release and emergency button.
7005.15.20 Juego rosetas ø53mm. con condena y desbloqueo / Set rosettes ø53mm. with locking knob release and emergency button.
7024.15.20 Juego rosetas cuadradas 37x37 mm. con condena y desbloqueo / Set square rosettes 37x37 mm. with locking knob release and emergency button.
7025.15.20 Juego rosetas cuadradas 53x53 mm. con condena y desbloqueo / Set square rosettes 53x53 mm. with locking knob release and emergency button.
7530.00.20 Pomo condena con botón de emergencia / Emergency and locking knob for bathroom.

Manillón Alzante

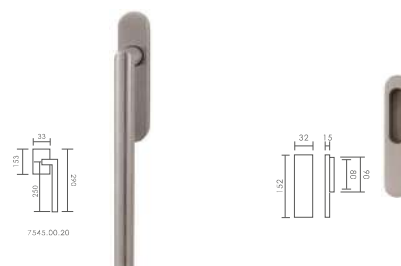

referencia

- 7545.00.20 Manillón alzante para ventanales de corredera / Pull handle for sliding windows.

acabados / finishes

- Acero Inoxidable (20)

Acero Aisi 316

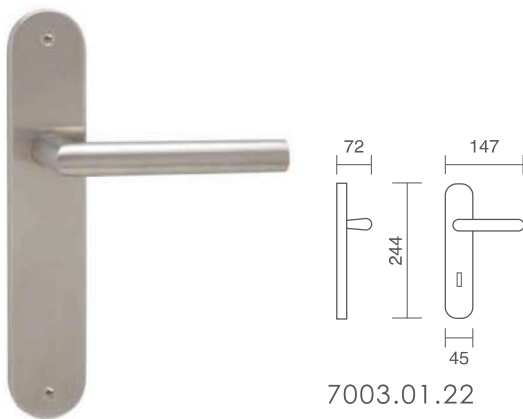

7003.01.22

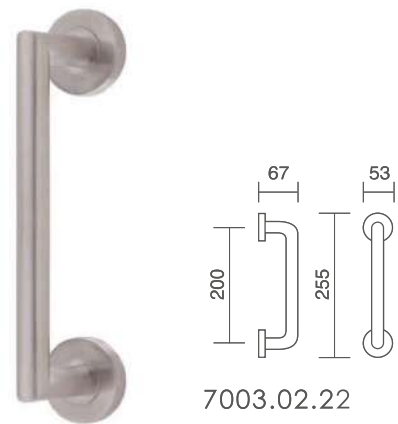

7003.02.22



7003.10.22



7500.00.22

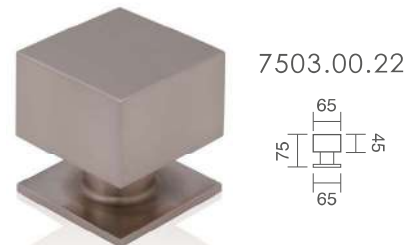

7503.00.22



7000.44.22



7005.15.22



7901



7902

referencia

| | |
|---------|---|
| 7003.01 | Juego manivelas con placa / Complete lever set with plate |
| 7003.02 | Manillón con rosetas de 200 mm. / Pull handel with rosettes 200 mm. |
| 7003.10 | Juego manivelas con rosetas / Complete lever set with rosette. |
| 7500.00 | Pomo de puerta / Door Knob |
| 7503.00 | Pomo puerta cuadrado 65x65 mm. / Door knob square shaped 65x65 mm. |
| 7000.44 | Roseta \varnothing 53 mm c/b viro / Rosette \varnothing 53 mm with key hole type yale |
| 7005.15 | Juego rosetas \varnothing 53 mm. con condena y desbloq. / Set rosettes \varnothing 53 mm with locking knob release and emergency button |
| 7901.08 | Bisagra canto recto derecha 90x65 mm / Hinge square shaped right hand 90x65 |
| 7901.09 | Bisagra canto recto izquierda 90x65 mm / Hinge square shaped left hand 90x65 |
| 7902.08 | Bisagra canto curvo derecha 90x65 mm / Hinge round shaped right hand 90x65 |
| 7902.09 | Bisagra canto curvo izquierda 90x65 mm / Hinge round shaped left hand 90x65 |

acabados / finishes

Acero inoxidable Aisi 316 (22) / Stainless Steel Aisi 316



Accesorios

Roseta redonda c/b



referencia

0900.14 Roseta redonda Ø 50 c/b viro / Key hole yale on rosette Ø 50 Mm

acabados / finishes Pulido Sat. (02) – Niquel Sat. (04) – Cuero (05) - Anticato (10) – Bronce Inglés (15) Cuero Yester (16) – Niquel Br. / Niq. Sat. (25) – Peltro (30) - Negro Mate (34)

0901.14 Roseta redonda canto recto Ø 50 c/b Viro / Key hole yale on rosette Ø 50 Mm

acabados / finishes Pulido Brillo (01) - Pulido Sat. (02) – Cromo Brillo (03) - Niquel Sat. (04) – Cuero (05) Cromo Sat. (08) - Anticato (10) – Cuero Yester (16) – Blanco Mate (26) – Peltro (30)

0900.44 Roseta redonda c/b viro para cerradura seguridad / Round rosette with key hole type yale security

acabados / finishes Pulido Brillo (01) – Cromo Brillo (03) – Niquel Sat. (04) – Cromo Sat. (08) Latón Sat. (09) – Anticato (10) – Cuero (15) – Negro Mate (34)

0900.34 Roseta redonda Ø 50 c/b borja / Key hole borja on rosette Ø 50 Mm.

acabados / finishes Pulido Sat. (02) – Anticato (10) – Bronce Inglés (15) - Cuero Yester (16) Niquel Br. / Niq. Sat. (25) – Peltro (30)

0901.34 Roseta redonda canto recto Ø 50 c/b borja / Key hole borja on rosette Ø 50 Mm.

acabados / finishes Cromo Brillo (03) – Niquel Sat. (04) - Anticato (10) - Cuero Yester (16) – Peltro (30)

Roseta cuadrada c/b

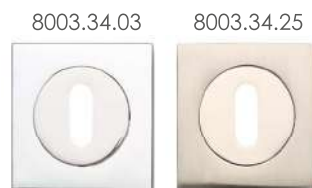

| referencia | |
|----------------------------|---|
| 8003.14 | Roseta Cuadrada C/b Viro / Key Hole Yale On Square Rosette |
| acabados / finishes | Pulido Sat. (02) – Cromo Brillo (03) – Niquel Sat. (04) – Cuero (05) Cromo Sat. (08) - Niquel Brillo / Niquel Sat. (25) – Negro Mate (34) |
| 4003.14 | Roseta Cuadrada C/b Viro / Square Rosette Witw Key Hole Type Yale |
| acabados / finishes | Anticato (10) – Cuero (15) |
| 8003.44 | Roseta Cuadrada C/b Viro Para Cerradura De Seguridad / Key Hole Yale On Square Rosette Security |
| acabados / finishes | Pulido Brillo (01) – Cromo Brillo (03) – Niquel Sat. (04) – Cromo Sat. (08) Latón Sat. (09) – Anticato (10) – Cuero (15) – Negro Mate (34) |
| 8003.34 | Roseta Cuadrada C/b Borja / Key Hole Type Borja On Square Rosette |
| acabados / finishes | Cromo Brillo (03) – Niquel Brillo/ Niquel Sat. (25) |

Condena con rosetas redondas

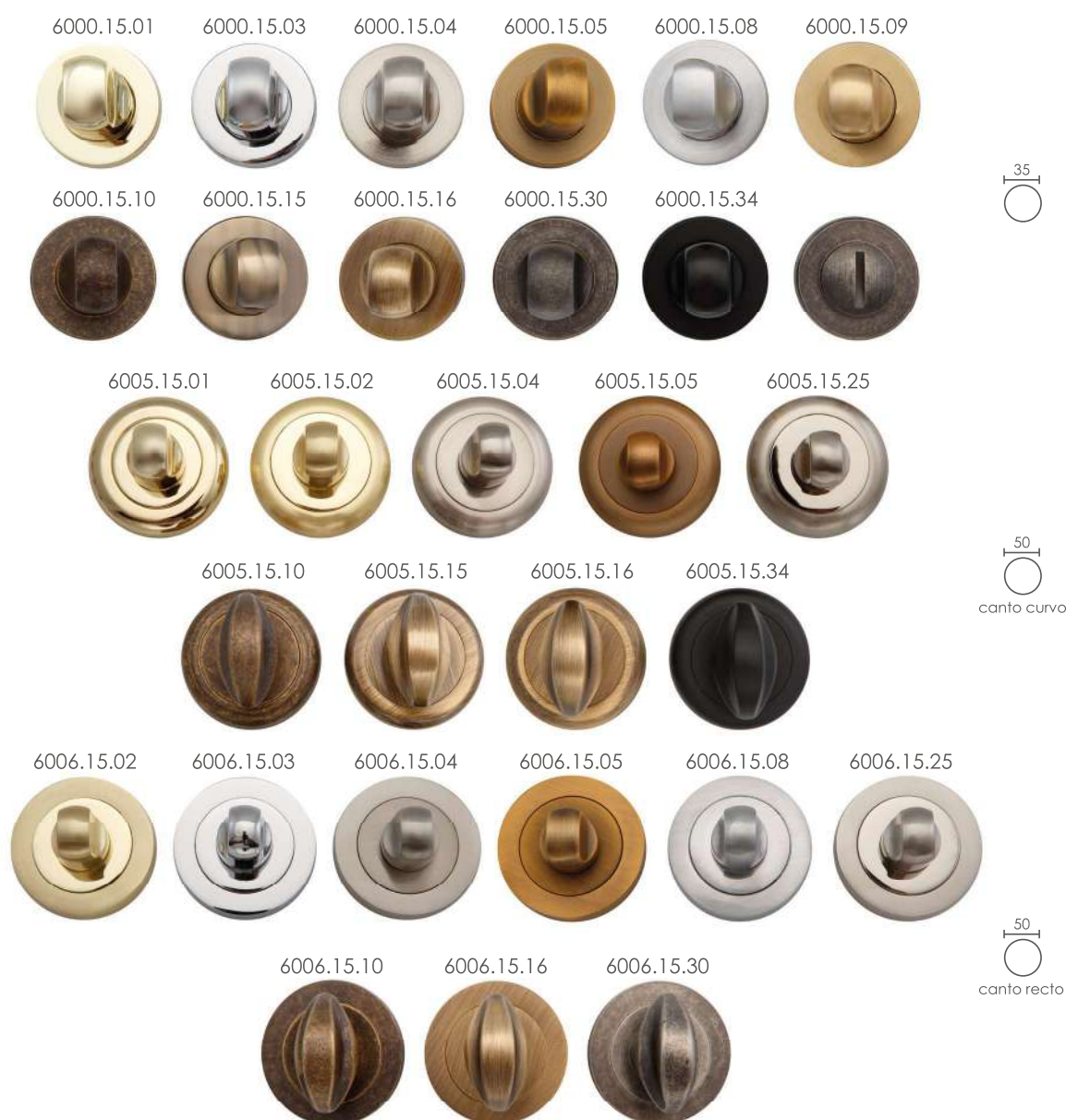

referencia

6000.15 Juego Rosetas Ø 35 Mm. con Condena y Desbloq.
Set Square Rosettes Ø 35 Mm. With Locking Knob Release And Emergency Button.

acabados / finishes Pul. Brillo (01) - Cromo Br. (03) - Niqu. Sat. (04) - Cuero (05) - Cromo Sat. (08) Latón Sat. (09)
 Antic. (10) - Bronce Inglés (15) - Cuero Yester (16) - Peltro (30) - Negro Mate (34)

6005.15 Juego Rtas. Canto Curvo Ø 50 Mm. Con Condena y Desbloq.
Set Square Rosettes Ø 50 Mm. With Locking Knob Release And Emergency Button.

acabados / finishes Pulido Brillo (01) - Pulido Sat. (02) - Niquel Sat. (04) - Cuero (05) - Niqu.br./niq. Sat. (25)
 Antic. (10) - Bronce Inglés (15) - Cuero Yester (16) - Peltro (30) - Negro Mate (34)

6006.15 Juego Rtas. Canto Recto Ø 50 Mm. Con Condena Y Desbloq.
Set Square Rosettes Ø 50 Mm. With Locking Knob Release And Emergency Button.

acabados / finishes Pulido Sat. (02) - Cromo Brillo (03) - Niquel Sat. (04) - Cuero (05) - Cromo Sat. (08)
 Niqu.br./niq. Sat. (25) Antic. (10) - Cuero Yester (16) - Peltro (30)

Condena con rosetas cuadrada

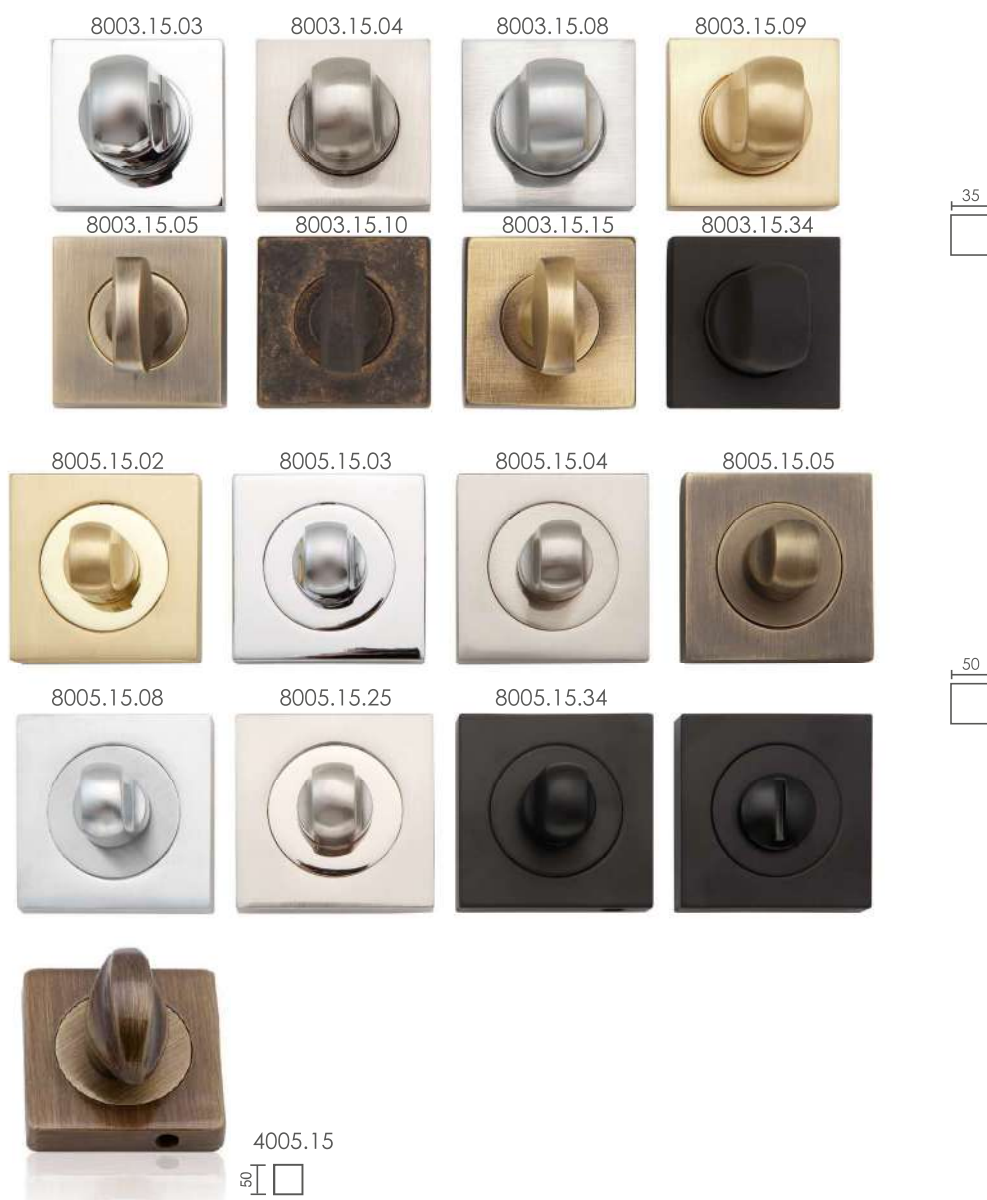

referencia

8003.15 Juego Rosetas cuadrada 35x35 mm. con condena y desbloq.
Set Square Rosettes 35x35 mm. with locking knob release and emergency button.

acabados / finishes Cromo Br. (03) – Níq. Sat. (04) – Cromo Sat. (08) Latón Sat. (09)
 Cuero (05) - Anticato (10) - Bronce Inglés (15) - Negro Mate (34)

8005.15 Juego Rtas. Cuadradas 50x50 mm. con condena y desbloq.
Set Square Rosettes 50x50 mm. with locking knob release and emergency button.

acabados / finishes Pulido Sat. (02) – Cromo Brillo (03) - Níquel Sat. (04) – Cuero (05) – Cromo Sat. (08)
 Níquel Brillo /Níquel Sat. (25) - Negro Mate (34)

4005.15 Juego Rtas. Cuadrada 50x50 mm. con condena y desbloq.
Set Square Rosettes 50x50 mm. with locking knob release and emergency button.

acabados / finishes Antic. (10) – Cuero (15)

Condensas para manivela

CON PLACA



| referencia | |
|--|--|
| 0520.00 | Pomo muletilla / Locking knob. |
| acabados / finishes | |
| 0530.00 | Pomo condensa con botón de emergencia / Emergency and locking knob for bathroom. |
| acabados / finishes | |
| Pulido brillo - Cromo brillo - Niquel Satinado - Cuero - Cromo Satinado - PVD - Anticato - Cuero Yester - Peltro | |

Roseta ovalada c/b

CUADRADILLOS EXPANSIVOS



| referencia | |
|--|---|
| 0850.14 | Roseta c/b Viro / Key hole on rosette |
| acabados / finishes | |
| Pulido brillo - Cromo brillo - Niquel Satinado - Niquel Negro - Cuero - Anticato | |
| referencia | |
| 0560.00 | Cuadradillo expansivo 8x8x65 mm / Strench out iron 8x8x65 |
| 0560.09 | Cuadradillo expansivo 8x8x90 mm / Strench out iron 8x8x90 |

Pomos de Puerta Mod. 500



| referencia | |
|---|-----------------------------|
| 0500.00 | Pomo de puerta / Door knob. |
| acabados / finishes | |
| Pulido Br.- Cromo Br.- Niquel Sat.- Cuero - Niquel Negro - Cromo Sat.- Anticato - PVD | |

Pomos de Puerta Mod. 515



| referencia | |
|---|-----------------------------|
| 0515.00 | Pomo de puerta / Door knob. |
| acabados / finishes | |
| Pulido Brillo - Niquel Satinado - Cuero | |

Pomos de Puerta



| referencia | |
|---------------------|--|
| 0500.00.20 | Pomo de puerta / Door knob. |
| 7500.00.20 | Pomo de puerta / Door knob. |
| 7515.00.20 | Pomo de puerta / Door knob. |
| 7503.00.20 | Pomo cuadrado de puerta / Door knob square shaped. |
| acabados / finishes | |
| Acero Inoxidable | |

Pomo de puerta Mod. 7500



7500.00.20



7500.00.28



7500.00.34

REFERENCIA CONCEPTO
7500.00 Pomo de puerta con base Ø 85 mm. / *Door knob with base Ø 85 mm.*

ACABADOS / FINISHES

Acero Inoxidable (20) · Grafito (28) · Negro Mate (34)

Tiradores de Armario



| referencia | |
|--|--|
| 4100.03 | Tirador maletero / Wardrobe pull on small plate. |
| 4100.05 | Tirador armario / Wardrobe pull on plate. |
| acabados / finishes | |
| Anticato - Peitro - Cuero - Negro Mate | |
| 3400.03 | Tirador maletero / Wardrobe pull on small plate. |
| 3400.05 | Tirador armario / Wardrobe pull on plate. |
| acabados / finishes | |
| Pulido Satinado - Niquel Satinado - Cromo Satinado | |
| 8003.03 | Tirador maletero / Wardrobe pull on small plate. |
| 8003.05 | Tirador armario / Wardrobe pull on plate. |
| acabados / finishes | |
| Niquel Satinado - Cuero - Anticato | |

Pomos de Armario



| referencia | |
|--|---|
| 7700.00.20 | Pomo cuadrado de 20mm. / Small knob square shaped 20mm. |
| 7715.00.20 | Pomo cuadrado de 25mm. / Small knob square shaped 25mm. |
| acabados / finishes | |
| Acero inoxidable | |
| 0600.00 | Pomo bola ø25mm. / Small knob ø25mm. |
| acabados / finishes | |
| Pulido Br. - Niquel Sat. - Cromo Sat. - Latón Sat. | |
| 0615.00 | Pomo bola ø30mm. / Small knob ø30mm. |
| acabados / finishes | |
| Pulido Br. - Niquel Sat. - Cromo Sat. | |

Turia MANILLONES



| referencia | |
|--|---|
| 8003.02 | Manillón con rosetas cuadradas / Pull handle with square rosettes. |
| acabados / finishes | |
| Niquel Brillo / Niquel Satinado | |
| 8003.25 | Manillón con rosetas redondas ø 50 mm. / Pull handle on round rosettes ø 50 mm. |
| acabados / finishes | |
| Pulido Satinado- Niquel Brillo / Niquel Satinado | |
| 8003.32 | Juego de manillones sin rosetas (posibilidad de montar sobre puerta de cristal / Set pull handle without rosettes for glass door. |
| acabados / finishes | |
| Pulido Satinado- Niquel Satinado | |

Bernia MANILLONES



| referencia | |
|---|--|
| 8002.02 | Manillón con rosetas de 180mm. mod. Bernia / Pull handle 180mm. with rosettes mod. Bernia. |
| acabados / finishes | |
| Pulido Satinado - Niquel Brillo / Niquel Satinado | |

Montgó

MANILLONES



| | | |
|----------------------------|---|---|
| referencia | 8012.02 | Manillón 200mm, con rosetas mod. Montgó / Pull handle 200mm, with rosettes mod. Montgó. |
| acabados / finishes | Pulido Br. - Pulido Sat. - Níquel Sat. - Cromo Sat. - Cuero Yester - Níquel Br. / Níquel Sat. | |
| | 8012.25 | Manillón 150mm, con rosetas mod. Montgó / Pull handle 150mm, with rosettes mod. Montgó. |
| acabados / finishes | Pulido Satinado - Níquel Satinado | |
| | 8012.42 | Manillón 200mm, con rosetas canto recto / Pull handle 200mm, with square shaped rosettes. |
| acabados / finishes | Pulido Satinado - Níquel Satinado - Cuero | |

Martina

MANILLONES



| | | | |
|-------------------|---------|-----------------|--|
| REFERENCIA | 1400.02 | CONCEPTO | Manillón sin rosetas de 200 mm. / Pull handle 200 mm, without rosettes |
|-------------------|---------|-----------------|--|

ACABADOS / FINISHES
 Cromo Brillo (03) - Latón Satinado (09) - Níquel Perla (12) - Cuero Yester (16)
 Grafito (28) - Peltro (30) - Negro Mate (34)

Asti

MANILLONES



| | | | |
|-------------------|---------|-----------------|--|
| REFERENCIA | 2540.02 | CONCEPTO | Manillón sin rosetas de 210 mm. / Pull handle 210 mm, without rosettes |
|-------------------|---------|-----------------|--|

ACABADOS / FINISHES
 Cromo Brillo (03) - Latón Satinado (09) - Níquel Perla (12) - Cuero Yester (16)
 Blanco Mate (26) - Grafito (28) - Peltro (30) - Negro Mate (34)

Alzante Modelo 3545

MANILLÓN



| | | | |
|-------------------|---------|-----------------|--|
| referencia | 3545.00 | CONCEPTO | Manillón alzante para ventanales de corredera / Pull handle for sliding windows. |
|-------------------|---------|-----------------|--|

acabados / finishes
 Pulido Brillo (01) - Níquel Satinado (04) - Cuero (05) - Latón Satinado (09) - Anticato (10)

Bisagras Seguridad

CON REMATE

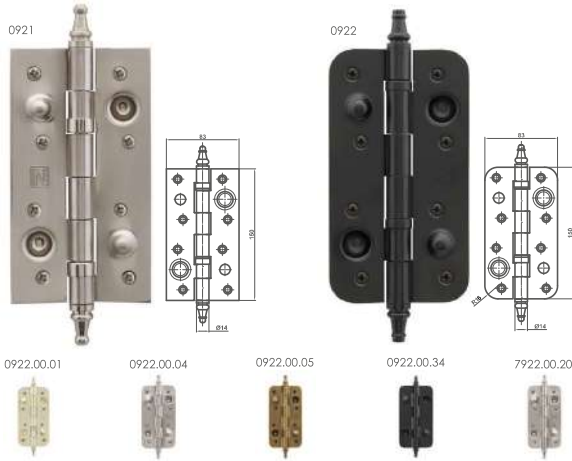

referencia

- 0921.00 Bisagra de seguridad con remate, canto recto, de 150x80x3 mm, con rodamientos. / Security hinges 150x80X3, with square shaped, with crown tip and with ball bearing.
- 0922.00 Bisagra de seguridad con remate, canto curvo (con radio de 16 mm.) De 150x80x3 mm, con rodamientos. / Security hinges 150x80X3, with round shaped "R 16", with crown tip and with ball bearing.

acabados / finishes

Pulido Brillo (01) - Níquel Satinado (04) - Cuero (05) - Negro Epoxy (34)
Polish Brass - Satin Nickel - Leather - Black Colour

referencia

- 7922.00 Bisagra de seguridad con remate, canto curvo (con radio de 16 mm.) De 150x80x3 mm, con rodamientos. / Security hinges 150x80X3, with round shaped "R 16", with crown tip and with ball bearing.

acabados / finishes

Acero inoxidable (20) / Stainless steel

Bisagras Seguridad

SIN REMATE

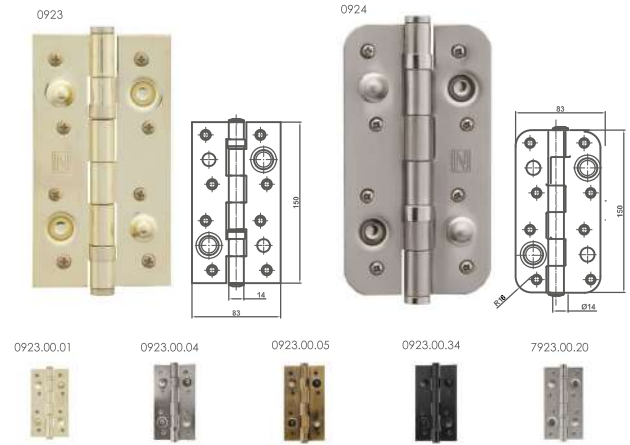

referencia

- 0923.00 Bisagra de seguridad sin remate, canto recto, de 150x80x3 mm, con rodamientos. / Security hinges 150x80X3, with square shaped, with flat tip and with ball bearing.
- 0924.00 Bisagra de seguridad sin remate, canto curvo (con radio de 16 mm.) De 150x80x3 mm, con rodamientos. / Security hinges 150x80X3, with round shaped "r 16", with flat tip and with ball bearing.

acabados / finishes

Pulido Brillo (01) - Níquel Satinado (04) - Cuero (05) - Blanco Mate (26) - Negro Epoxy (34)
Polish Brass - Satin Nickel - Leather - Matt White - Black Colour

referencia

- 7923.00 Bisagra de seguridad sin remate, canto recto, de 150x80x3 mm, con rodamientos. / Security hinges 150x80X3, with square shaped, with flat tip and with ball bearing.
- 7924.00 Bisagra de seguridad sin remate, canto curvo (con radio de 16 mm.) De 150x80x3 mm, con rodamientos. / Security hinges 150x80X3, with round shaped "R 16", with flat tip and with ball bearing.

acabados / finishes

Acero inoxidable (20) / Stainless steel

Pernio Acero Inoxidable

REMATE CURVO

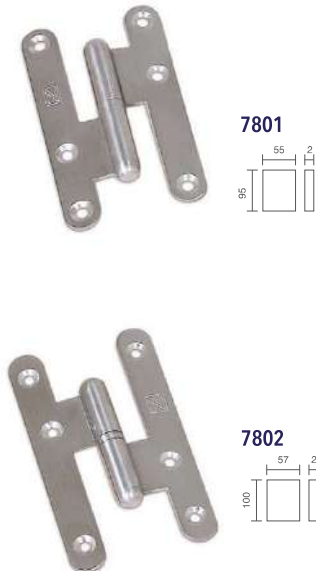

REFERENCIA

- 7801.08 Pernio derecha 95x55x2 / Hinge right hand 95x55x2
7801.09 Pernio izquierda 95x55x2 / Hinge left hand 95x55x2
7802.08 Pernio derecha 100x57x2 / Hinge right hand 100x57x2
7802.09 Pernio izquierda 100x57x2 / Hinge left hand 100x57x2

ACABADOS / FINISHES

Acero Inoxidable (20) - Negro Mate (34)

Pernio Acero Inoxidable

REMATE RECTO



REFERENCIA

- 7811.08 Pernio derecha remate recto 95x55x2 / Hinge right hand with terminal right 95x55x2
7811.09 Pernio izquierda remate recto 95x55x2 / Hinge left hand with terminal right 95x55x2
7812.08 Pernio derecha remate recto 100x57x2 / Hinge right hand with terminal right 100x57x2
7812.09 Pernio izquierda remate recto 100x57x2 / Hinge left hand with terminal right 100x57x2

ACABADOS / FINISHES

Acero Inoxidable (20) - Negro Mate (34)

Bisagra Pernio

90x65

Cuero (05)



Latón Satinado (09)



Acero Inox. (20)



7901

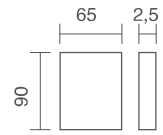

Blanco Mate (26)



Grafito (28)



Negro Mate (34)



Cuero (05)



Latón Satinado (09)



Acero Inox. (20)



7902

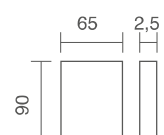

Blanco Mate (26)



Grafito (28)



Negro Mate (34)



| REFERENCIA | CONCEPTO |
|------------|---|
| 7901.08 | Pernio mano derecha canto recto 90x65x2.5 / Hinge square shaped right hand 90x65x2.5 |
| 7901.09 | Pernio mano izquierda canto recto 90x65x2.5 / Hinge square shaped left hand 90x65x2.5 |
| 7902.08 | Pernio mano derecha canto curvo 90x65x2.5 / Hinge round shaped right hand 90x65x2.5 |
| 7902.09 | Pernio mano izquierda canto curvo 90x65x2.5 / Hinge round shaped left hand 90x65x2.5 |

Grisan Mod. 3400



referencia

3400.17 Grisán / Dreh kipp.

acabados / finishes

Pulido Brillo (01) - Níquel Satinado (04) - Bronce Inglés (15) - Cuero Yester (16)

Topes de Puerta



referencia

0890.00 Tope puerta de media luna / Door stopper.

acabados / finishes

Níquel Satinado (04)

referencia

7895.00 Tope puerta columna / Door Stopper

acabados / finishes

Acero Inoxidable (20)

Llamadores de Puertas



810
108x215mm.

800
95x215mm.



950
106x164mm.

940
106x164mm.

referencia

800.00 Llamador puerta / Door knocker.

acabados / finishes Pulido Br - Cromo Br - Níq. Sat. - Níq. Negro - Cromo Sat. - PVD

810.00 Llamador puerta / Door knocker.

acabados / finishes Níquel Negro - PVD

940.00 Llamador cabeza de león / Lion's head knocker.

acabados / finishes Pulido Br - Níq. Negro

950.00 Llamador aro de 130 mm. / Ring knocker 130 mm.

acabados / finishes Pulido Br - Níq. Sat.

Accesorios

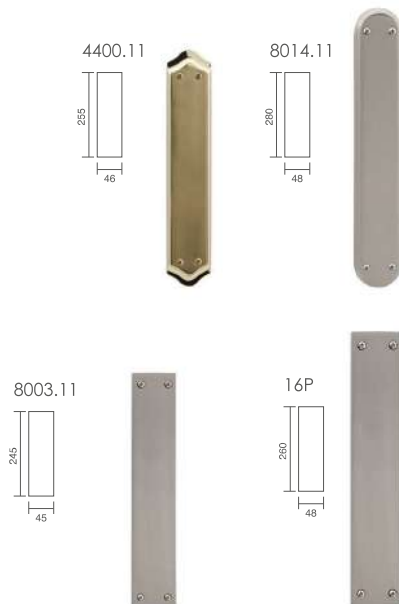

referencia

- 4400.11 Placa de limpieza / Plate. Pulido Sat. (02) - Níquel Sat. (04) - Cuero (05)
- 8014.11 Placa de limpieza 280x48 mm. / Plate. Pulido Sat. (02) - Níquel Sat. (04) - Cuero (05)
- 8003.11 Placa de limpieza / Plate. Cromo Brillo (03) - Níquel Sat. (04)
- 16P Placa de limpieza 260x48 mm. / Plate. Cromo Brillo (03) - Níquel Sat. (04) Cuero (05) Lat. Sat. (09)

Pomos con placa



referencia

- 4400.12 Pomo móvil (loco) c/placa / Mobile knob with plate. Pulido Sat. (02) - Níquel Sat. (04) - Cuero (05)
- 4400.16 Pomo fijo c/placa / Fixe knob with plate. Pulido Sat. (02) - Níquel Sat. (04) - Cuero (05)
- 4400.20 Juego pomos c/placa / Knobs Set with plate. Pulido Sat. (02) - Níquel Sat. (04) - Cuero (05)
- 8014.12 Pomo móvil (loco) c/placa / Mobile knob with plate. Pulido Sat. (02) - Níquel Sat. (04) - Cuero (05)
- 8014.16 Pomo fijo c/placa / Fixe knob with plate. Pulido Sat. (02) - Níquel Sat. (04) - Cuero (05)
- 8014.20 Juego pomos c/placa / Knobs Set with plate. Pulido Sat. (02) - Níquel Sat. (04) - Cuero (05)
- 8003.12 Pomo móvil (loco) c/placa / Mobile knob with plate. Níquel Sat. (04)
- 8003.16 Pomo fijo c/placa / Fixe knob with plate. Níquel Sat. (04)
- 8003.20 Juego pomos c/placa / Knobs Set with plate. Níquel Sat. (04)

Soporte Pasamanos

7543.00

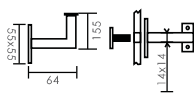

0540.01



0540.05

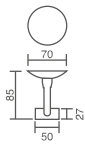

0540.20



0540.34

referencia

7543.00 Soporte pasamanos cuadrato / Quadrato Support Handrail Holder
Acero Inox. (20)

0540.00 Soporte pasamanos / Support Handrail Holder
Pulido Brillo (01) - Cuero (05) - Acero Inox. (20) - Negro Epoxy (34)

Aros para suplementar

ROSETA

7550.00.20



0550.00



referencia

0550.00 Aro exterior para suplementar roseta / Hoop rosette.

acabados / finishes Pulido Br.- Niquel Sat.- Cuero - Cromo Sat.- Latón Sat.- Anticato - Cuero Yester

referencia

7550.00.20 Aro exterior para suplementar roseta en acero inoxidable / Stainless steel hoop rosette.

Pasadores Mod. 570

0570

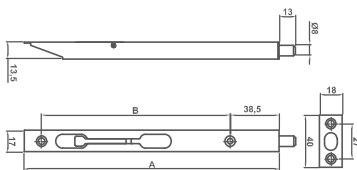

0563.00.01 0563.00.04 0563.00.34

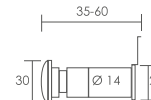

0564.00.01 0564.00.04 0564.00.34

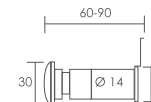

referencia

| | | A | B |
|---------|---|--------|--------|
| 0570.01 | Pasador de embutir de 150mm. / Bolt for pressing 150mm. | 162mm. | 110mm. |
| 0570.02 | Pasador de embutir de 200mm. / Bolt for pressing 200mm. | 200mm. | 148mm. |
| 0570.03 | Pasador de embutir de 250mm. / Bolt for pressing 250mm. | 250mm. | 198mm. |
| 0570.04 | Pasador de embutir de 300mm. / Bolt for pressing 300mm. | 300mm. | 248mm. |
| 0570.05 | Pasador de embutir de 400mm. / Bolt for pressing 400mm. | 400mm. | 348mm. |
| 0570.06 | Pasador de embutir de 500 mm. / Bolt for pressing 500 mm. | 500mm. | 448mm. |
| 0570.07 | Pasador de embutir de 600 mm. / Bolt for pressing 600 mm. | 600mm. | 548mm. |

acabados / finishes

Pulido Brillo (01) - Acero Inoxidable (20)

Mirillas

REFERENCIA

CONCEPTO

0563.00 Mirilla de 35-60, ángulo de vision 180°
/ Door viewer fits door 35-60 mm. with lid built in angle 180°

0564.00 Mirilla de 60-90, ángulo de vision 180°
/ Door viewer fits door 60-90 mm. with lid built in angle 180°

ACABADOS / FINISHES

Pulido Brillo (01) - Niquel Sat. (04) - Negro Mate (34)

Asa cajonera Mod. 880



REFERENCIA CONCEPTO
0880.00 Asa cajonera / Card Handle

ACABADOS / FINISHES

Pulido Brillo (01) · Níquel Satinado (04) · Cuero (05) ·
Latón Satinado (09) · Blanco Mate (26) · Negro Mate (34)



Cerrajería

Picaporte unificado 47 mm

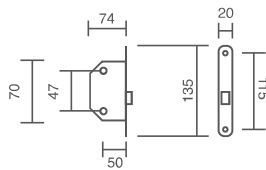

referencia

5210.00 Picaporte unificado de 47mm. entre ejes con frontal redondeado.

acabados / finishes

Latón Satinado - Níquel Satinado - Cuero - Anticato - Negro Mate

Picaporte unificado 70 mm

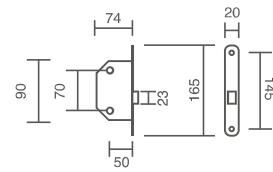

referencia

5220.00 Picaporte unificado de 70mm. entre ejes con frontal redondeado.

acabados / finishes

Latón Satinado - Níquel Satinado - Cuero - Anticato - Negro Mate - Grafito (28)

Picaporte silencioso 70 mm

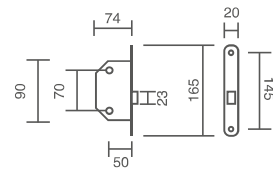

referencia

5230.00 Picaporte silencioso de 70mm. entre ejes con frontal redondeado.

acabados / finishes

Latón Satinado - Níquel Satinado - Cuero - Anticato

Cerradura magnética

Cerradura Mod. 5300-5301

C/B VIRO 47 MM.

5201.50

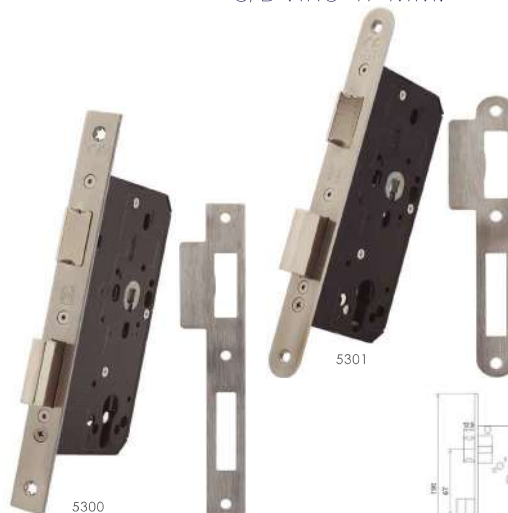
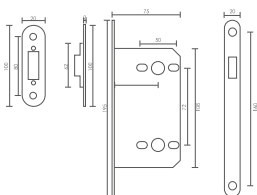

Cerradura de embutir c/b viro a 47mm., con picaporte reversible, bombillo serreta 60mm. (30 - 30) con 6 pistones, un pin de acero antilaladro y con 3 llaves de latón niqueladas

Mortise lock, with key hole at 47mm., reversible chrome plated brass tongue, with cylinder of normal keys 60mm. (30 - 30), with three nickel plated keys, six pins and with one antidrilling stainless steel.

| referencia |
|--|
| 5201.50 Cerradura magnética C/b Viro 72 mm. Entrada 50 mm. con adaptador para condensa y cerradero regulable. Magnetic lock with key hole type yale 72 mm. backset 50 mm. with adapter for deadbolt and latch adjustable. |

| acabados / finishes |
|---|
| Pulido Brillo (01) · Niquel Sat. (04) · Negro Mate (34) |

| referencia | concepto | distancia ejes | distancia entrada |
|------------|--------------------------------|----------------|-------------------|
| 5300.40 | Cerradura canto recto c/b viro | 47mm. | 40mm. |
| 5300.50 | Cerradura canto recto c/b viro | 47mm. | 50mm. |
| 5301.40 | Cerradura canto curvo c/b viro | 47mm. | 40mm. |

acabados / finishes Pulido Brillo (01) - Niq. Sat. (04)

| referencia | concepto | distancia ejes | distancia entrada |
|------------|--------------------------------|----------------|-------------------|
| 5301.50 | Cerradura canto curvo c/b viro | 47mm. | 50mm. |

acabados / finishes Pulido Brillo (01) - Niq. Sat. (04) - Cuero (05) - Negro mate (34)

Cerraduras 5320-5321

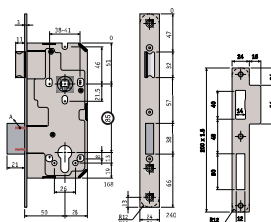
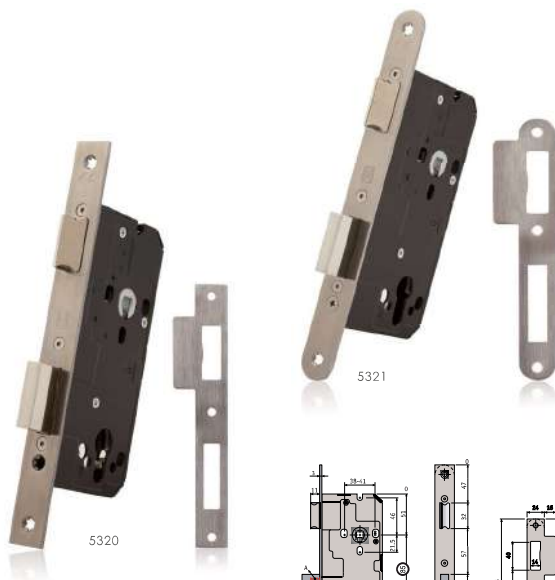

Cerradura de embutir para puertas de madera. Picaporte reversible de acero cromado. Desplazamiento de dos vueltas (20mm.)

| referencia | concepto | distancia ejes | distancia entrada |
|------------|-----------------------------------|----------------|-------------------|
| 5320.45 | Cerradura canto recto c/b viro. | 85 mm. | 45 mm. |
| 5320.50 | Cerradura canto recto c/b viro. | 85 mm. | 50 mm. |
| 5320.60 | Cerradura canto recto c/b viro. | 85 mm. | 60 mm. |
| 5321.45 | Cerradura canto redondo c/b viro. | 85 mm. | 45 mm. |
| 5321.50 | Cerradura canto redondo c/b viro. | 85 mm. | 50 mm. |
| 5321.60 | Cerradura canto redondo c/b viro. | 85 mm. | 60 mm. |

acabados / finishes:

Latón Salfinado (09) - Acero Inoxidable (20) - Negro mate (34)

Cerradura Mod. 5310-5311

C/B VIRO 70

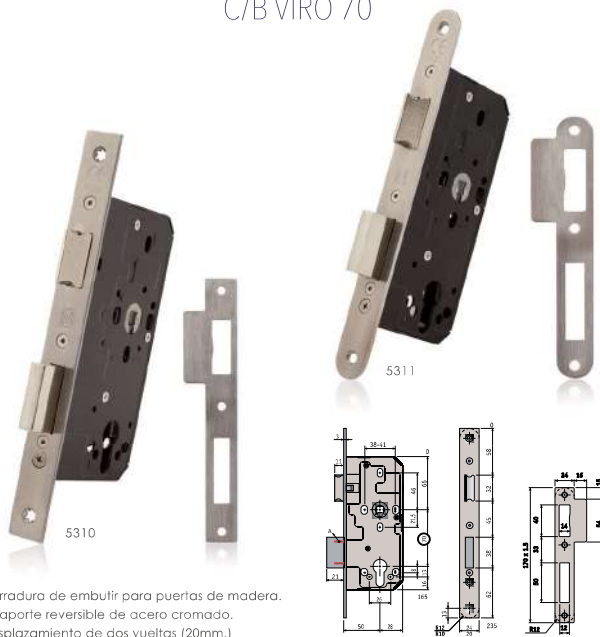

Cerradura de embutir para puertas de madera.
Picaporte reversible de acero cromado.
Desplazamiento de dos vueltas (20mm.)

| referencia | | distancia ejes | distancia entrada |
|------------|-----------------------------------|----------------|-------------------|
| 5310.50 | Cerradura canto recto c/b viro. | 70 mm. | 50 mm. |
| 5310.60 | Cerradura canto recto c/b viro. | 70 mm. | 60 mm. |
| 5311.60 | Cerradura canto redondo c/b viro. | 70 mm. | 60 mm. |

acabados / finishes:
Latón Satinado (09) - Acero Inoxidable (20)

| referencia | | distancia ejes | distancia entrada |
|------------|-----------------------------------|----------------|-------------------|
| 5311.50 | Cerradura canto redondo c/b viro. | 70 mm. | 50 mm. |

acabados / finishes:
Latón Satinado (09) - Acero Inoxidable (20) - Negro mate

Modelo 5314

PARA PUERTA DE PASO

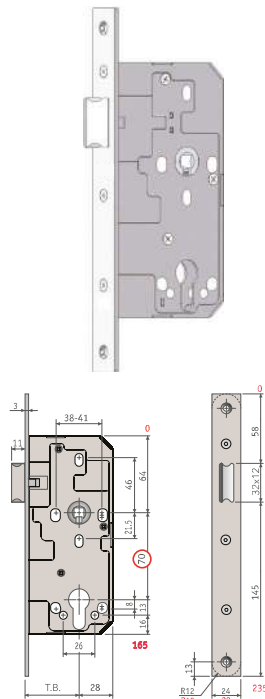

| referencia | | distancia ejes | distancia entrada |
|------------|---|----------------|-------------------|
| 5314.50 | Cerradura canto redondo con resbalón para accionar sólo con manivela. | 70 mm. | 50 mm. |

acabados / finishes:
Acero Inoxidable (20) - Negro mate

Modelo 5316

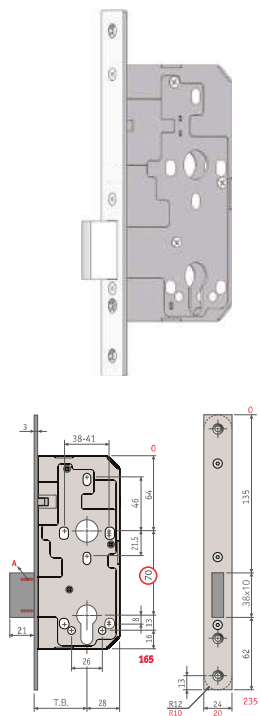

| referencia | | distancia ejes | distancia entrada |
|------------|--|----------------|-------------------|
| 5316.50 | Cerradura canto redondo con resbalón para accionar sólo con bombillo | 70 mm. | 50 mm. |

acabados / finishes:
Acero Inoxidable (20) - Negro mate

Modelo 5317

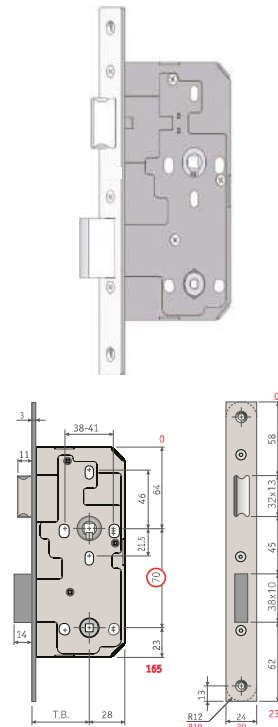

| referencia | | distancia ejes | distancia entrada |
|------------|--|----------------|-------------------|
| 5317.50 | Cerradura canto redondo con resbalón para accionar con condena | 70 mm. | 50 mm. |

acabados / finishes:
Acero Inoxidable (20) - Negro mate

Cerradura Monopunto Canto Recto

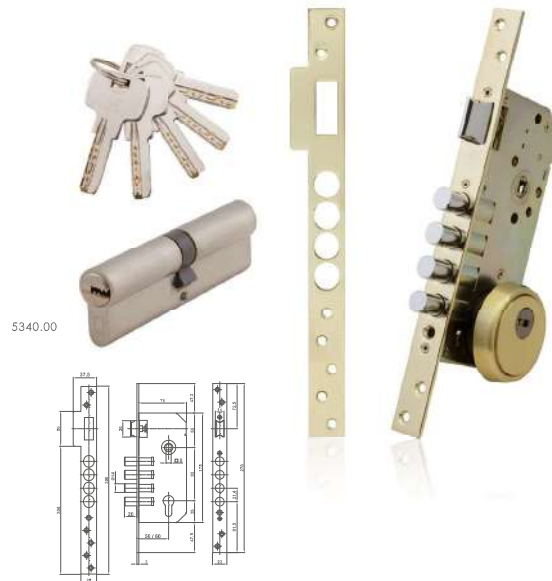

referencia

5340.00 Cerradura monopunto, canto recto, con picaporte reversible, distancia entre ejes 85mm., distancia de entrada 50mm., 4 bulones cromados de Ø14mm. y desplazamiento de 20mm. (2 vueltas), con escudo de seguridad nulacvi, bombillo seguridad 60mm. (30-30) con 6 pitones y un pin de acero antitaladro, con 5 llaves de latón niqueladas.

High security mortise lock, with key hole type yale at 85mm., reversible chrome plated brass tongue, squared shaped, opening 50mm, four chrome plated bolts of 14mm., movement 20mm., with security escutcheon and security cylinder 60mm. with 6 pins and with 1 antidrilling stainless steel, with five nickel plated brass keys.

acabados / finishes

Pulido Brillo (01) - Cuero (05) - Acero Inoxidable (20) - Negro Epoxy (34)

Cerradura Monopunto Canto Curvo



referencia

5341.00 Cerradura monopunto, canto curvo, con picaporte reversible, distancia entre ejes 85mm., distancia de entrada 50mm., 4 bulones cromados de Ø14mm. y desplazamiento de 20mm. (2 vueltas), con escudo de seguridad nulacvi, bombillo seguridad 60mm. (30-30) con 6 pitones y un pin de acero antitaladro, con 5 llaves de latón niqueladas.

High security mortise lock, with key hole type yale at 85mm., reversible chrome plated brass tongue, round shaped, opening 50mm, four chrome plated bolts of 14mm., movement 20mm., with security escutcheon and security cylinder 60mm, with 6 pins and with 1 antidrilling stainless steel, with five nickel plated brass keys.

acabados / finishes

Pulido Brillo (01) - Cuero (05) - Acero Inoxidable (20) - Negro Epoxy (34)

Bombillo Serreta



Cilindro de latón con 6 pitones y 1 de acero antilaladro.
Cada cilindro incorpora tres llaves de latón niqueladas.
Muelles de acero inoxidable.
Leva de 15mm.
Tornillo de métrica 5x60 mm.

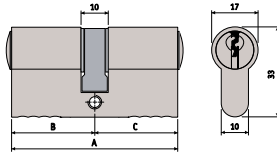

| referencia | A | B | C |
|------------|----------------------------------|--------|--------|
| 6600.00 | Bombillo de 60 mm. | 30 mm. | 30 mm. |
| 6601.00 | Bombillo de 61 mm. | 35 mm. | 26 mm. |
| 6610.00 | Bombillo de 70 mm. | 35 mm. | 35 mm. |
| 6611.00 | Bombillo de 70 mm. | 40 mm. | 30 mm. |
| 6620.00 | Bombillo de 80 mm. | 40 mm. | 40 mm. |
| 6621.00 | Bombillo de 80 mm. | 45 mm. | 35 mm. |
| | CILINDROS DE SERRETA CON CONDENA | | |
| 6609.00 | Bombillo de 60 mm. | 30 mm. | 30 mm. |
| 6619.00 | Bombillo de 70 mm. | 35 mm. | 35 mm. |

acabados / finishes:

Níquel Satinado (04) - Latón Satinado (09)

Bombillo Seguridad



Cilindro de latón con 6 pitones y 1 de acero antilaladro.
Cada cilindro incorpora cinco llaves de latón niqueladas.
Muelles de acero inoxidable.
Leva de 15mm.
Tornillo de métrica 5x60 mm.

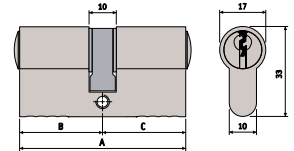

| referencia | A | B | C |
|------------|------------------------------------|--------|--------|
| 6700.00 | Bombillo de 60 mm. | 30 mm. | 30 mm. |
| 6701.00 | Bombillo de 61 mm. | 35 mm. | 26 mm. |
| 6710.00 | Bombillo de 70 mm. | 35 mm. | 35 mm. |
| 6711.00 | Bombillo de 70 mm. | 40 mm. | 30 mm. |
| 6720.00 | Bombillo de 80 mm. | 40 mm. | 40 mm. |
| 6721.00 | Bombillo de 80 mm. | 45 mm. | 35 mm. |
| 6730.00 | Bombillo de 90 mm. | 45 mm. | 45 mm. |
| 6731.00 | Bombillo de 90 mm. | 50 mm. | 40 mm. |
| 6740.00 | Bombillo de 100 mm. | 50 mm. | 50 mm. |
| 6741.00 | Bombillo de 100 mm. | 55 mm. | 45 mm. |
| | CILINDROS DE SEGURIDAD CON CONDENA | | |
| 6709.00 | Bombillo de 60 mm. | 30 mm. | 30 mm. |
| 6719.00 | Bombillo de 70 mm. | 35 mm. | 35 mm. |
| 6729.00 | Bombillo de 80 mm. | 40 mm. | 40 mm. |

acabados / finishes:

Níquel Satinado (04) - Latón Satinado (09)

Amaestramientos

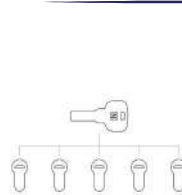

nº1 Llaves iguales

Todas las puertas se abren con la misma llave.



nº2 Maestra simple

Cada llave abre su puerta y la llave maestra abre todas las puertas.



nº5 Por grupos

Cada puerta abre con su llave, con la del grupo y con la maestra general.

Adaptadores para condena y llave borja



0561



0562

referencia

- 0561.00.00 Adaptador convertidor de cerradura c/b viro a condena / adapter converter for lock with key hole yale to lock with key hole for bathroom.
0562.00.00 Adaptador convertidor de cerradura c/b viro a bocallave borja.
/ adapter converter for lock with key hole yale to lock with key hole for borja.

Bombillos de Seguridad HS10



Con doble embrague resistente al bumping, antiganzuable, con ranuración en los extremos para evitar manipulaciones externas y con doble pitón de acero antitaladro.

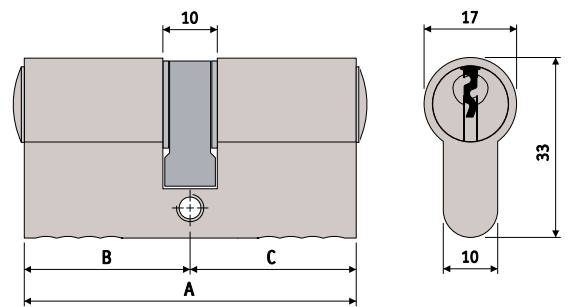

| referencia | A | B | C |
|------------|---------------------|--------|--------|
| 6900.00 | Bombillo de 60 mm. | 30 mm. | 30 mm. |
| 6910.00 | Bombillo de 70 mm. | 35 mm. | 35 mm. |
| 6911.00 | Bombillo de 70 mm. | 40 mm. | 30 mm. |
| 6920.00 | Bombillo de 80 mm. | 40 mm. | 40 mm. |
| 6921.00 | Bombillo de 80 mm. | 45 mm. | 35 mm. |
| 6922.00 | Bombillo de 80 mm. | 50 mm. | 30 mm. |
| 6930.00 | Bombillo de 90 mm. | 45 mm. | 45 mm. |
| 6931.00 | Bombillo de 90 mm. | 50 mm. | 40 mm. |
| 6932.00 | Bombillo de 90 mm. | 60 mm. | 30 mm. |
| 6933.00 | Bombillo de 90 mm. | 55 mm. | 35 mm. |
| 6940.00 | Bombillo de 100 mm. | 50 mm. | 50 mm. |
| 6941.00 | Bombillo de 100 mm. | 55 mm. | 45 mm. |
| 6942.00 | Bombillo de 100 mm. | 60 mm. | 40 mm. |
| 6951.00 | Bombillo de 110 mm. | 60 mm. | 50 mm. |
| 6952.00 | Bombillo de 110 mm. | 70 mm. | 40 mm. |
| 6900.00 | Llaves vírgenes | | |

acabados / finishes:

Niquel Satinado (04) - Latón Satinado (09)

Kit con condena Mod. 5000



referencia

5000.00 Kit para puerta corredera con condena / *Sliding door lock set.*

acabados / finishes

Pulido Brillo (01) - Cromo Brillo (03) - Níquel Satinado (04) - Cromo satinado (08) - Latón sat. (09) Anticato (10) - Níquel Perla (12) - Cuero Yester (16) - Blanco Mate (26) - Grafito (28) - Peltro (30) Negro mate (34)

Kit con condena Mod. 5000.40



referencia

5000.40 Kit de puerta corredera sin cerradura / *Sliding door lock set without lock.*

acabados / finishes

Pulido Brillo (01) - Cromo Brillo (03) - Níquel Satinado (04) - Cromo satinado (08) - Latón sat. (09) Anticato (10) - Níquel Perla (12) - Cuero Yester (16) - Blanco Mate (26) - Grafito (28) - Peltro (30) Negro mate (34)

Kit con condena Mod. 5001



referencia

5001.00 Kit para puerta corredera con condena / Sliding door lock set.

acabados / finishes

Pulido Brillo - Níquel Satinado - Cuero

Kit con condena Mod. 5003



referencia

5003.00 Kit rosetas cuadradas para puerta corredera con condena / Sliding door lock set with square rosettes.

acabados / finishes

Pulido Brillo (01) - Cromo Brillo (03) - Níquel Satinado (04) - Cromo satinado (08) - Latón sat. (09) Anticato (10) - Níquel Perla (12) - Cuero Yester (16) - Blanco Mate (26) - Grafito (28) - Peltro (30) Negro mate (34)

Kit con condena Mod. 5001.40



referencia

5001.40 Kit de puerta corredera sin cerradura / Sliding door without lock set.

acabados / finishes

Pulido Brillo - Níquel Satinado - Cuero

Kit con condena Mod. 5003.40



referencia

5003.40 Kit de puerta corredera sin cerradura con roseta cuadrada / Sliding door lock set without lock on square rosette.

acabados / finishes

Pulido Brillo (01) - Cromo Brillo (03) - Níquel Satinado (04) - Cromo satinado (08) - Latón sat. (09) Anticato (10) - Níquel Perla (12) - Cuero Yester (16) - Blanco Mate (26) - Grafito (28) - Peltro (30) Negro mate (34)

Kit con condena



referencia

5005.00 Kit para puerta corredera c/b viro / Sliding door lock set with key hole.

5005.01 Kit con bombillo / Sliding door lock set with cylinder.

5006.00 Kit rosetas cuadradas para puerta corredera c/b viro / Sliding door lock set with square rosette and key hole.

5006.01 Kit rlas. cuadradas con bombillo / Sliding door lock set with square rosete and with cylinder.

5105.00 Cerradura para puerta corredera c/b viro / Lock for sliding door with key hole.

acabados / finishes

Pulido Brillo (01) - Níquel Satinado (04) - Cuero (16) - Negro Mate (34)

Kit con condena Mod. 5004



referencia

5004.00 Kit de puerta corredera con llave / Sliding door lock set with key.

acabados / finishes

Pulido Brillo - Níquel Satinado - Cuero

Accesorios Puerta Corredera



referencia

5100.00 Cerradura para puerta corredera / Lock for sliding door.

5000.42 Uñero para puerta corredera / Small rosette for sliding door.

acabados / finishes

Pulido Brillo - Níquel Satinado - Cromo Satinado - Cuero - Blanco Mate - Negro Mate - Peltro



CITY LINE
MANILLONES

London Led

6104.D4.20

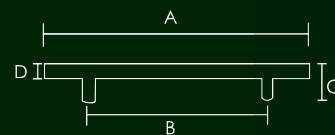

6 luces Led

6 luces Led

Sensor detector de movimientos

Sistema Led alimentado por 4 pilas AA

| REFERENCIA | CONCEPTO | A | B | C | D |
|------------|---|------|------|----|----|
| 6104.D2.20 | Manillón Led / <i>Led Light Pull Handle</i> | 400 | 200 | 80 | 20 |
| 6104.D4.20 | Manillón Led / <i>Led Light Pull Handle</i> | 1000 | 600 | 80 | 20 |
| 6104.D6.20 | Manillón Led / <i>Led Light Pull Handle</i> | 1800 | 1400 | 80 | 20 |

ACABADOS / FINISHES
Acero Inoxidable (20)

London

6104.U2.34

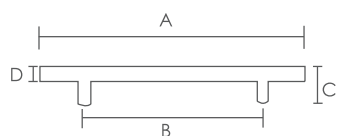

6104.U3.20



6104.L3.20

| REFERENCIA | CONCEPTO | A | B | C | D |
|------------|--|------|------|----|----|
| 6104.L2.20 | Juego de Manillones Mod. London / <i>Set pull handle Mod. London</i> | 400 | 200 | 80 | 30 |
| 6104.L3.20 | Juego de Manillones Mod. London / <i>Set pull handle Mod. London</i> | 600 | 400 | 80 | 30 |
| 6104.L4.20 | Juego de Manillones Mod. London / <i>Set pull handle Mod. London</i> | 1000 | 600 | 80 | 30 |
| 6104.L5.20 | Juego de Manillones Mod. London / <i>Set pull handle Mod. London</i> | 1400 | 1200 | 80 | 30 |
| 6104.L6.20 | Juego de Manillones Mod. London / <i>Set pull handle Mod. London</i> | 1800 | 1400 | 80 | 30 |
| 6104.U2.20 | Manillón Mod. London / <i>Pull handle Mod. London</i> | 400 | 200 | 80 | 30 |
| 6104.U3.20 | Manillón Mod. London / <i>Pull handle Mod. London</i> | 600 | 400 | 80 | 30 |
| 6104.U4.20 | Manillón Mod. London / <i>Pull handle Mod. London</i> | 1000 | 600 | 80 | 30 |
| 6104.U5.20 | Manillón Mod. London / <i>Pull handle Mod. London</i> | 1400 | 1200 | 80 | 30 |
| 6104.U6.20 | Manillón Mod. London / <i>Pull handle Mod. London</i> | 1800 | 1400 | 80 | 30 |

ACABADOS / FINISHES

Acero Inoxidable (20)

| REFERENCIA | CONCEPTO | A | B | C | D |
|------------|---|------|------|----|----|
| 6104.U2.34 | Manillón Mod. London / <i>Pull handle Mod. London</i> | 400 | 200 | 80 | 30 |
| 6104.U3.34 | Manillón Mod. London / <i>Pull handle Mod. London</i> | 600 | 400 | 80 | 30 |
| 6104.U4.34 | Manillón Mod. London / <i>Pull handle Mod. London</i> | 1000 | 600 | 80 | 30 |
| 6104.U6.34 | Manillón Mod. London / <i>Pull handle Mod. London</i> | 1800 | 1400 | 80 | 30 |

ACABADOS / FINISHES

Negro Mate (34)

Berlín



7104.U2.20

7104.L2.20

| REFERENCIA | CONCEPTO | A | B | C | D |
|------------|--|------|------|----|-------|
| 7104.L2.20 | Juego de Manillones Mod. Berlín / <i>Set pull handle Mod. Berlin</i> | 400 | 200 | 80 | 25x25 |
| 7104.L3.20 | Juego de Manillones Mod. Berlín / <i>Set pull handle Mod. Berlin</i> | 600 | 400 | 80 | 25x25 |
| 7104.L4.20 | Juego de Manillones Mod. Berlín / <i>Set pull handle Mod. Berlin</i> | 1000 | 600 | 80 | 25x25 |
| 7104.L5.20 | Juego de Manillones Mod. Berlín / <i>Set pull handle Mod. Berlin</i> | 1400 | 1200 | 80 | 25x25 |
| 7104.U2.20 | Manillón Mod. Berlín / <i>Pull handle Mod. Berlin</i> | 400 | 200 | 80 | 25x25 |
| 7104.U3.20 | Manillón Mod. Berlín / <i>Pull handle Mod. Berlin</i> | 600 | 400 | 80 | 25x25 |
| 7104.U4.20 | Manillón Mod. Berlín / <i>Pull handle Mod. Berlin</i> | 1000 | 600 | 80 | 25x25 |
| 7104.U5.20 | Manillón Mod. Berlín / <i>Pull handle Mod. Berlin</i> | 1400 | 1200 | 80 | 25x25 |

ACABADOS / FINISHES

Acero Inoxidable (20)

Manillones Modelo 7006

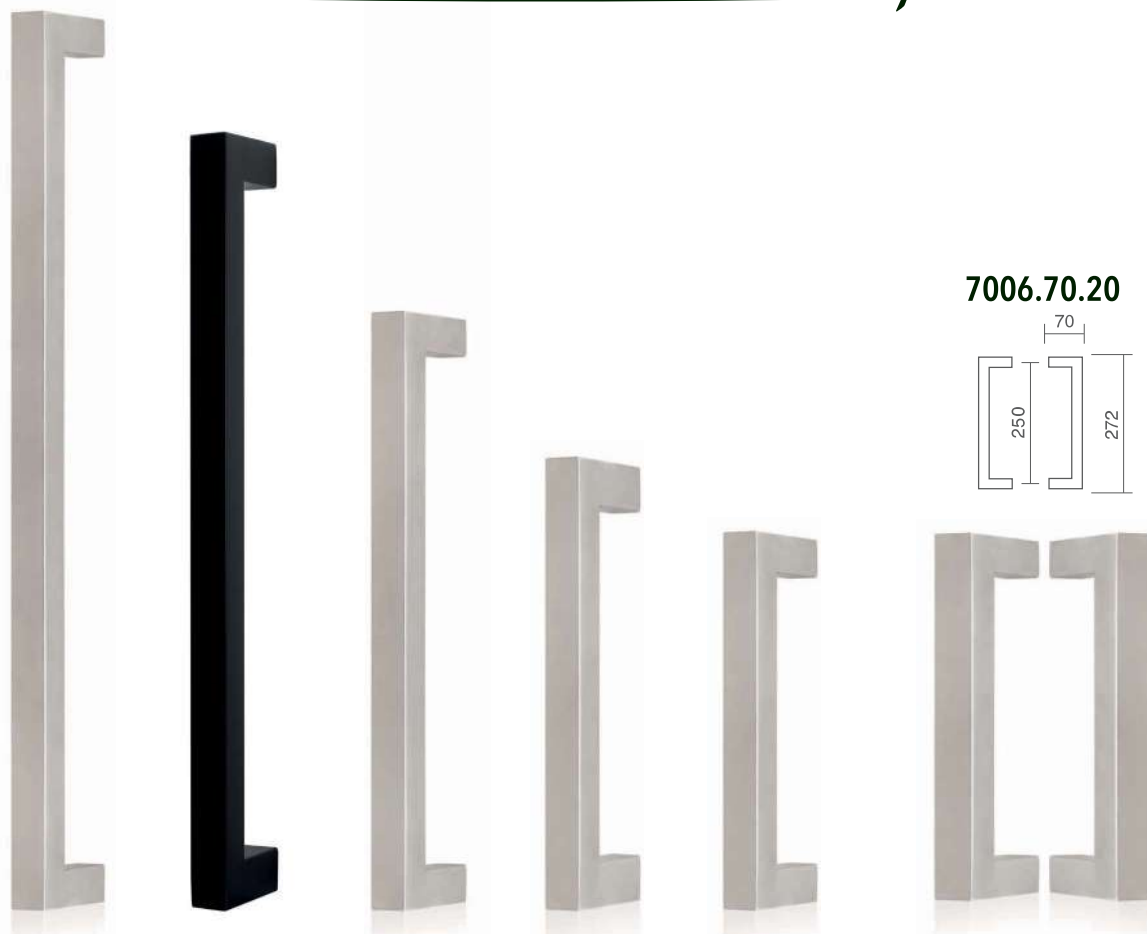

7006.84.20 7006.83.34 7006.82.20 7006.81.20 7006.80.20

| REFERENCIA | CONCEPTO |
|------------|--|
| 7006.70 | Juego de Manillones 25 x 25 x 250 mm. / <i>Set pull handle 25 x 25 x 250 mm.</i> |
| 7006.71 | Juego de Manillones 25 x 25 x 400 mm. / <i>Set pull handle 25 x 25 x 400 mm.</i> |
| 7006.72 | Juego de Manillones 25 x 25 x 600 mm. / <i>Set pull handle 25 x 25 x 600 mm.</i> |
| 7006.73 | Juego de Manillones 25 x 25 x 1000 mm. / <i>Set pull handle 25 x 25 x 1000 mm.</i> |
| 7006.74 | Juego de Manillones 25 x 25 x 1200 mm. / <i>Set pull handle 25 x 25 x 1200 mm.</i> |

| | |
|---------|--|
| 7006.80 | Manillón de 25 x 25 x 250 mm. / <i>Pull handle 25 x 25 x 250 mm.</i> |
| 7006.81 | Manillón de 25 x 25 x 400 mm. / <i>Pull handle 25 x 25 x 400 mm.</i> |
| 7006.82 | Manillón de 25 x 25 x 600 mm. / <i>Pull handle 25 x 25 x 600 mm.</i> |
| 7006.83 | Manillón de 25 x 25 x 1000 mm. / <i>Pull handle 25 x 25 x 1000 mm.</i> |
| 7006.84 | Manillón de 25 x 25 x 1200 mm. / <i>Pull handle 25 x 25 x 1200 mm.</i> |

ACABADOS / FINISHES
Acero Inoxidable (20)

| REFERENCIA | CONCEPTO |
|------------|--|
| 7006.80 | Manillón de 25 x 25 x 250 mm. / <i>Pull handle 25 x 25 x 250 mm.</i> |
| 7006.81 | Manillón de 25 x 25 x 400 mm. / <i>Pull handle 25 x 25 x 400 mm.</i> |
| 7006.82 | Manillón de 25 x 25 x 600 mm. / <i>Pull handle 25 x 25 x 600 mm.</i> |

ACABADOS / FINISHES
Negro Mate (34)

Shanghai

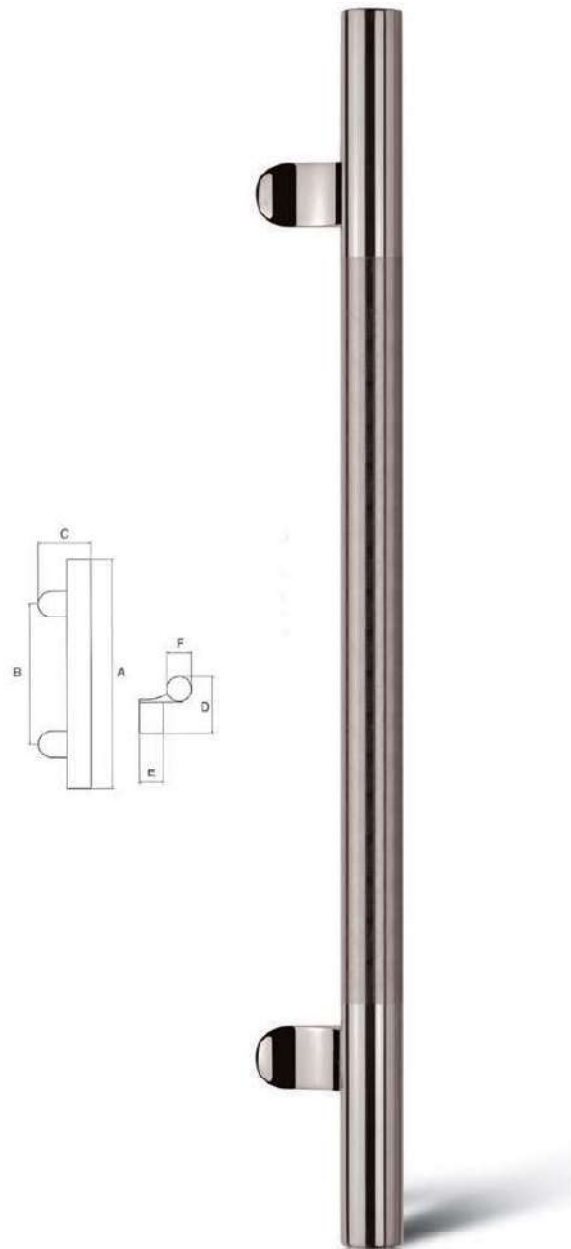

| REFERENCIA | A | B | C | D | E | F |
|------------|------|------|----|----|----|----|
| 6105.U2 | 400 | 250 | 76 | 75 | 32 | 32 |
| 6105.U3 | 600 | 425 | 76 | 75 | 32 | 32 |
| 6105.U4 | 1000 | 700 | 76 | 75 | 32 | 32 |
| 6105.U6 | 1800 | 1400 | 76 | 75 | 32 | 32 |

ACABADOS / FINISHES
Acero Brillo/Acero Inoxidable (25)

Sidney



6101.U2.25

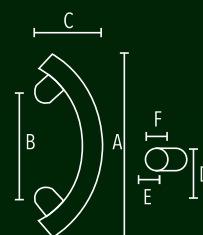

REFERENCIA
6101.U2.25

CONCEPTO
Manillón Sidney / *Pull handle Sidney*

| A | B | C | D | E | F |
|-----|-----|-----|----|----|----|
| 610 | 430 | 120 | 75 | 32 | 32 |

ACABADOS / FINISHES
Acero Brillo / Acero Inoxidable (25)

Miami

Berna

6114.U2.25



8104.U2.20

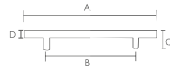

REFERENCIA 6114.U2.25
CONCEPTO Manillón Miami / Pull handle Miami

| A | B | C | D |
|-----|-----|-----|----|
| 610 | 430 | 120 | 32 |

ACABADOS / FINISHES
Acero Inoxidable brillo (25)

REFERENCIA 8104.U2.20
CONCEPTO Manillón Berna / Pull handle Berna

| A | B | C | D |
|-----|-----|----|----|
| 400 | 200 | 80 | 25 |
| 600 | 400 | 80 | 25 |

ACABADOS / FINISHES
Acero Inoxidable (20)

Accesorios

KIT MANILLÓN

| Imagen | Producto | Cantidad |
|--------|---|----------|
| | Almohadillas protectoras de vidrio | 2 |
| | Tornillos de fijación de 110 mm M8 | 2 |
| | Tornillos de fijación de 110 mm M8 con manguitos | 2 |
| | Tornillos de fijación de 65 mm M8 con manguitos | 2 |
| | Manguito de fijación acanalado en V | 2 |
| | Tornillo prisionero de métrica 6 | 2 |
| | Llave Allen para prisionero de métrica 6 | 1 |
| | Llave Allen para manguito de fijación | 1 |
| | Embellecedor redondo para espárrago M8 | 2 |
| | Tornillo para metalurgia Métrica 6 Longitud 45 mm cabeza Phillips, para montaje sin traspasar la puerta | 2 |

Para modelos London, Berlin, Shanghai, Sidney, Berna.



Herraje Rústico

Asolo

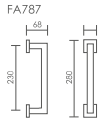
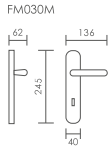
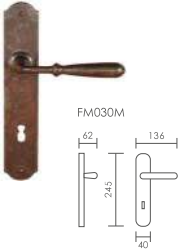
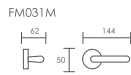

referencia

- FM030M Juego de Manivelas con placa / Complete lever with plate.
- FM031M Juego de Manivelas con roseta / Complete lever with rosette.
- FA787 Manillón con rosetas / Pull handle with rosettes.
- FM066 Grísán / Dreh klipp
- FB712 Roseta de 50 mm. C/B viro / Key hole yale on rosette ø 50 mm.
- FB711 Roseta de 50 mm. C/B borja / Key hole borja on rosette ø 50 mm.
- FM307P Juego de Rosetas Ø 50 mm. Con condena y desbloqueo / Set rosettes ø 50 mm with locking knob release and emergency button.

acabados / finishes

Rugine (37)

Bolonia

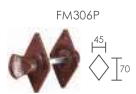
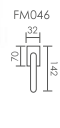
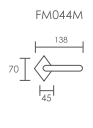
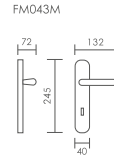

referencia

- FM043M Juego de Manivelas con placa / Complete lever with plate.
- FM044M Juego de Manivelas con roseta / Complete lever with rosette.
- FM049 Manillón alzante / Pull handle for sliding windows
- FM046 Grísán / Dreh klipp
- FB717 Roseta de 50 mm. C/B viro / Key hole yale on rosette ø 50 mm.
- FB716 Roseta de 50 mm. C/B borja / Key hole borja on rosette ø 50 mm.
- FM306P Juego de Rosetas Ø 50 mm. Con condena y desbloqueo / Set rosettes ø 50 mm with locking knob release and emergency button.

acabados / finishes

Rugine (37)

Parma

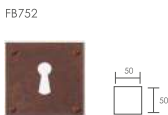
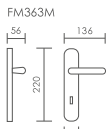
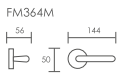

referencia

- FM363M Juego Manivelas con placa / Complete lever with plate.
- FM364M Juego Manivelas con roseta / Complete lever with rosette.
- FB753 Roseta de 50x50 mm. C/B viro / Key hole yale on rosette 50x50 mm.
- FB752 Roseta de 50x50 mm. C/B borja / Key hole borja on rosette 50x50 mm.
- FM373 Juego Rosetas 50x50 mm. Con condena y desbloq. / Set rosettes 50x50 mm with locking knob release and emergency button.

acabados / finishes

Rugine (37)

Manillones, Pomos y Llamadores

FA781.20 - FA781.25



FA787



FM019



FM302B - FM302A



FA796.70



FA798.BIS



FA791



referencia

- FA781.20 Asa manillón □ 14x14x200 mm. / Forged iron pull handle □ 14x14x200 mm
- FA781.25 Asa manillón □ 16x16x250 mm. / Forged iron pull handle □ 16x16x250 mm
- FA787 Manillón c/rosetas Ø 50x270 mm. / Iron pull handle ø 50x270 mm
- FM019 Manillón con placa 30x175 mm. / Pull handle on plate 30x175 mm
- FM302B Asa tirador ø 8x120 mm / Forged iron pull handle ø 8x120 mm
- FM302A Asa tirador ø 10x185 mm / Forged iron pull handle ø 10x185 mm

- FA796.70 Pomo de puerta ø 70 mm. / Iron door knob ø 70 mm.
- FA798.BIS Juego de pomos 70 mm. / Set iron door knob 70 mm.
- FA791 Llamador de puerta 120x150 mm. / Iron door knocker 120x150 mm.

acabados / finishes

Rugine (37)

Pasadores y Pernios

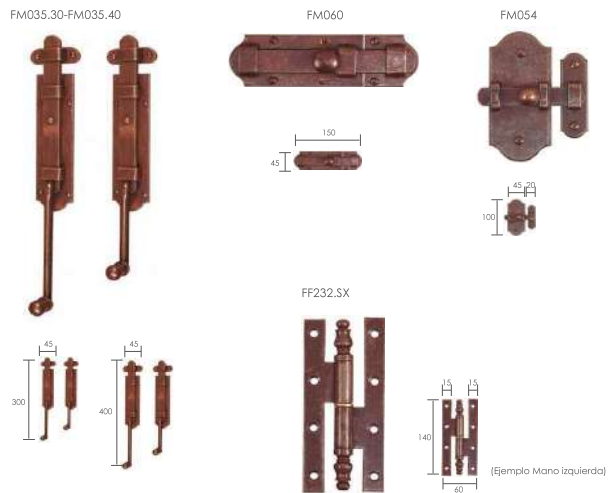

referencia

FM035.30 Pasador vertical de 45x300 mm./ Vertical bolt 45x300 mm
 FM035.40 Pasador vertical de 45x400 mm./ Vertical bolt 45x400 mm
 FM060 Pasador de 45x150 mm./ Iron bolt 45x150 mm
 FM054 Pasador de 70x100 mm./ Iron bolt 70x100 mm
 FF232.DX Pernio derecha 60x140 mm./ Right iron hinge 60x140 mm
 FF232.SX Pernio izquierda 60x140 mm./ Left iron hinge 60x140 mm

acabados / finishes

Rugine (37)

Pomos y Tiradores

PARA PUERTA CORREDERA

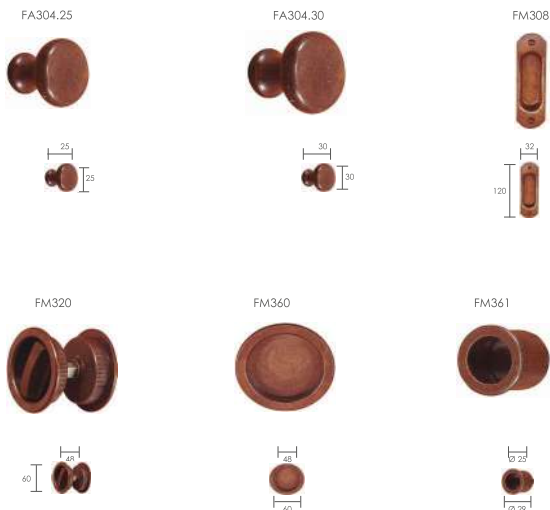

referencia

FA304.25 Pomo tirador ø 25 mm./ Iron knob ø 25 mm
 FA304.30 Pomo tirador ø 30 mm./ Iron knob ø 30 mm
 FM308 Tirador embutir ovalado 120x32 mm./ Inset iron handle 120x32 mm.
 FM320 Kit rosetas condensa para puerta corredera / Sliding door lock set.
 FM360 Tirador uñero de embutir ø 48 mm. / Inset iron handle ø 48 mm
 FM361 Tirador de embutir ø 25 mm. / Inset iron handle ø 25 mm

acabados / finishes

Rugine (37)

Accesorios para ventana

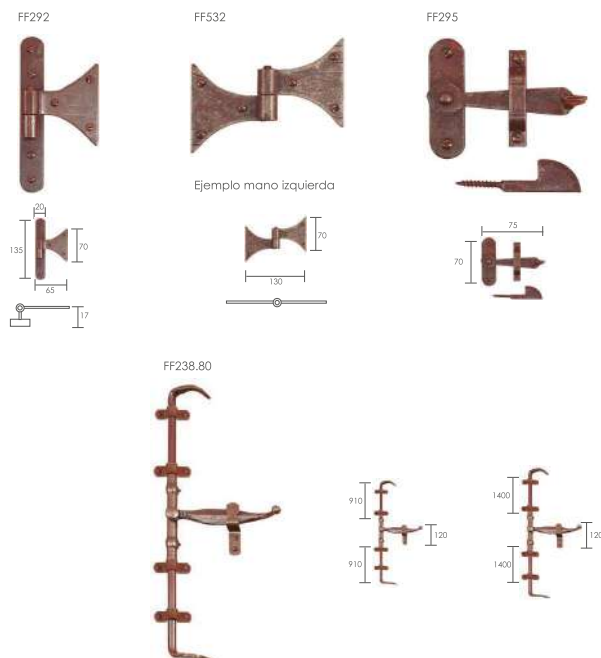

referencia

FF292 Bisagra simple (no guarda mano) / Simple hinge for windows.
 FF532.DX Bisagra dcha. 130x70 mm. / Right hinge 130x70 mm.
 FF532.SX Bisagra izqda. 130x70 mm / Left hinge 130x70 mm.
 FF295 Pasador ventana 70x75 mm. / Iron bolt for window 70x75 mm.
 FF238.80 Kit herraje ventana con 2 varillas 900 mm / Set hardware for window with two 900 mm rods.
 FF238.140 Kit herraje ventana con 2 varillas 1.400 mm / Set hardware for window with two 1.400 mm rods

acabados / finishes

Rugine (37)

Kit completo para el montaje DE PUERTAS CORREDERAS

FF039.01

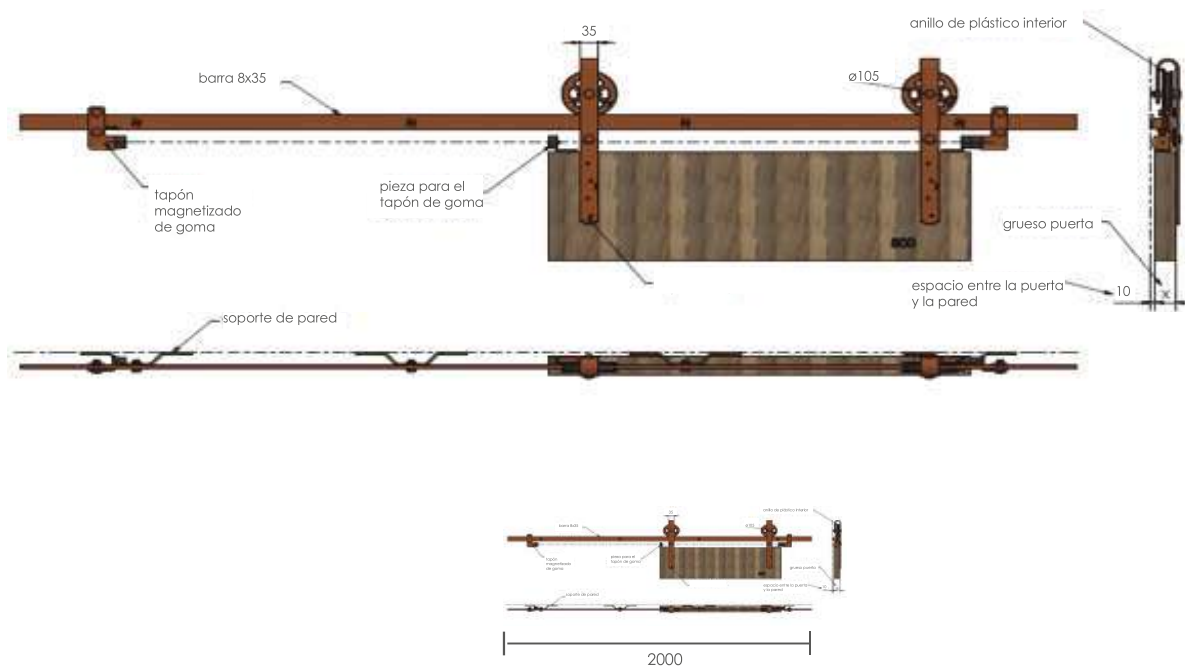

referencia

- FF039.01 Kit de herrajes para el montaje de una puerta corredera con barra máxima de 2 m.
FF039.02 Kit de herrajes para el montaje de dos puertas correderas con 2 barras máximas de 2 m.

acabados / finishes

Rugine (37)

Cerraduras Modelo FS190.45 - FS190.65

FS190.45 - FS190.65

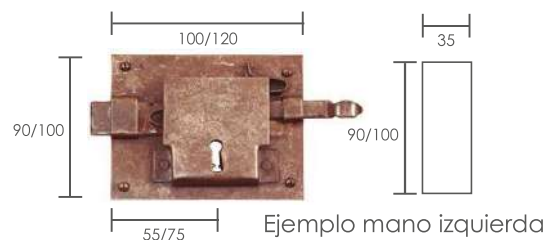

referencia

| | |
|---------------|---|
| FS190.45.DX.1 | Cerrad. Dcha. C/B 45 mm. De 100x90 mm. Con llave nº1 |
| FS190.45.DX.2 | Cerrad. Dcha. C/B 45 mm. De 100x90 mm. Con llave nº2 |
| FS190.45.DX.3 | Cerrad. Dcha. C/B 45 mm. De 100x90 mm. Con llave nº3 |
| FS190.45.DX.4 | Cerrad. Dcha. C/B 45 mm. De 100x90 mm. Con llave nº4 |
| FS190.45.DX.5 | Cerrad. Dcha. C/B 45 mm. De 100x90 mm. Con llave nº5 |
| FS190.45.DX.6 | Cerrad. Dcha. C/B 45 mm. De 100x90 mm. Con llave nº6 |
| FS190.45.DX.7 | Cerrad. Dcha. C/B 45 mm. De 100x90 mm. Con llave nº7 |
| FS190.45.DX.8 | Cerrad. Dcha. C/B 45 mm. De 100x90 mm. Con llave nº8 |
| FS190.45.SX.1 | Cerrad. Izqda. C/B 45 mm. De 100x90 mm. Con llave nº1 |
| FS190.45.SX.2 | Cerrad. Izqda. C/B 45 mm. De 100x90 mm. Con llave nº2 |
| FS190.45.SX.3 | Cerrad. Izqda. C/B 45 mm. De 100x90 mm. Con llave nº3 |
| FS190.45.SX.4 | Cerrad. Izqda. C/B 45 mm. De 100x90 mm. Con llave nº4 |
| FS190.45.SX.5 | Cerrad. Izqda. C/B 45 mm. De 100x90 mm. Con llave nº5 |
| FS190.45.SX.6 | Cerrad. Izqda. C/B 45 mm. De 100x90 mm. Con llave nº6 |
| FS190.45.SX.7 | Cerrad. Izqda. C/B 45 mm. De 100x90 mm. Con llave nº7 |
| FS190.45.SX.8 | Cerrad. Izqda. C/B 45 mm. De 100x90 mm. Con llave nº8 |

acabados / finishes

Nero (36) Rugine (37)

referencia

| | |
|---------------|--|
| FS190.65.DX.1 | Cerrad. Dcha. C/B 65 mm. De 120x100 mm. Con llave nº1 |
| FS190.65.DX.2 | Cerrad. Dcha. C/B 65 mm. De 120x100 mm. Con llave nº2 |
| FS190.65.DX.3 | Cerrad. Dcha. C/B 65 mm. De 120x100 mm. Con llave nº3 |
| FS190.65.DX.4 | Cerrad. Dcha. C/B 65 mm. De 120x100 mm. Con llave nº4 |
| FS190.65.DX.5 | Cerrad. Dcha. C/B 65 mm. De 120x100 mm. Con llave nº5 |
| FS190.65.DX.6 | Cerrad. Dcha. C/B 65 mm. De 120x100 mm. Con llave nº6 |
| FS190.65.DX.7 | Cerrad. Dcha. C/B 65 mm. De 120x100 mm. Con llave nº7 |
| FS190.65.DX.8 | Cerrad. Dcha. C/B 65 mm. De 120x100 mm. Con llave nº8 |
| FS190.65.SX.1 | Cerrad. Izqda. C/B 65 mm. De 120x100 mm. Con llave nº1 |
| FS190.65.SX.2 | Cerrad. Izqda. C/B 65 mm. De 120x100 mm. Con llave nº2 |
| FS190.65.SX.3 | Cerrad. Izqda. C/B 65 mm. De 120x100 mm. Con llave nº3 |
| FS190.65.SX.4 | Cerrad. Izqda. C/B 65 mm. De 120x100 mm. Con llave nº4 |
| FS190.65.SX.5 | Cerrad. Izqda. C/B 65 mm. De 120x100 mm. Con llave nº5 |
| FS190.65.SX.6 | Cerrad. Izqda. C/B 65 mm. De 120x100 mm. Con llave nº6 |
| FS190.65.SX.7 | Cerrad. Izqda. C/B 65 mm. De 120x100 mm. Con llave nº7 |
| FS190.65.SX.8 | Cerrad. Izqda. C/B 65 mm. De 120x100 mm. Con llave nº8 |

acabados / finishes

Rugine (37)

Cerraduras Modelo FS192

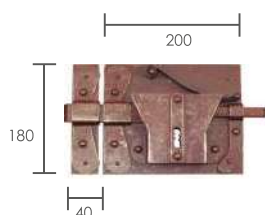

Ejemplo mano izquierda

referencia

| | |
|------------|---|
| FS192.DX.1 | Cerrad. Dcha. C/B 105 mm. de 200x180 con llave N°1 |
| FS192.DX.2 | Cerrad. Dcha. C/B 105 mm. de 200x180 con llave N°2 |
| FS192.DX.3 | Cerrad. Dcha. C/B 105 mm. de 200x180 con llave N°3 |
| FS192.DX.4 | Cerrad. Dcha. C/B 105 mm. de 200x180 con llave N°4 |
| FS192.DX.5 | Cerrad. Dcha. C/B 105 mm. de 200x180 con llave N°5 |
| FS192.DX.6 | Cerrad. Dcha. C/B 105 mm. de 200x180 con llave N°6 |
| FS192.SX.1 | Cerrad. Izqda. C/B 105 mm. de 200x180 con llave N°1 |
| FS192.SX.2 | Cerrad. Izqda. C/B 105 mm. de 200x180 con llave N°2 |
| FS192.SX.3 | Cerrad. Izqda. C/B 105 mm. de 200x180 con llave N°3 |
| FS192.SX.4 | Cerrad. Izqda. C/B 105 mm. de 200x180 con llave N°4 |
| FS192.SX.5 | Cerrad. Izqda. C/B 105 mm. de 200x180 con llave N°5 |
| FS192.SX.6 | Cerrad. Izqda. C/B 105 mm. de 200x180 con llave N°6 |

acabados / finishes

Nero (36) Ruginé (37)

Cerraduras Modelo FS195

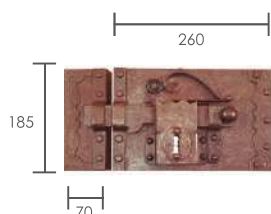

Ejemplo mano izquierda

referencia

| | |
|------------|---|
| FS195.DX.1 | Cerrad. Dcha. C/B 100 mm. de 260x185 con llave nº1 |
| FS195.DX.2 | Cerrad. Dcha. C/B 100 mm. de 260x185 con llave nº2 |
| FS195.DX.3 | Cerrad. Dcha. C/B 100 mm. de 260x185 con llave nº3 |
| FS195.DX.4 | Cerrad. Dcha. C/B 100 mm. de 260x185 con llave nº4 |
| FS195.DX.5 | Cerrad. Dcha. C/B 100 mm. de 260x185 con llave nº5 |
| FS195.DX.6 | Cerrad. Dcha. C/B 100 mm. de 260x185 con llave nº6 |
| FS195.SX.1 | Cerrad. Izqda. C/B 100 mm. de 260x185 con llave nº1 |
| FS195.SX.2 | Cerrad. Izqda. C/B 100 mm. de 260x185 con llave nº2 |
| FS195.SX.3 | Cerrad. Izqda. C/B 100 mm. de 260x185 con llave nº3 |
| FS195.SX.4 | Cerrad. Izqda. C/B 100 mm. de 260x185 con llave nº4 |
| FS195.SX.5 | Cerrad. Izqda. C/B 100 mm. de 260x185 con llave nº5 |
| FS195.SX.6 | Cerrad. Izqda. C/B 100 mm. de 260x185 con llave nº6 |

acabados / finishes

Rugine (37)

Cerraduras con manivela

FM250



Ejemplo mano izquierda

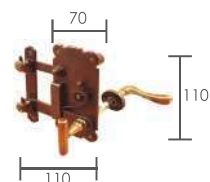

FM250BIS



Ejemplo mano derecha

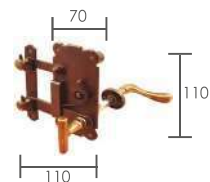

referencia

| | |
|--------------|---|
| FM250.DX | Cerradura dcha. con manivela y pasador. |
| FM250.SX | Cerradura izqda. con manivela y pasador. |
| FM250.BIS.DX | Cerradura dcha. con manivela, pasador y condena. |
| FM250.BIS.SX | Cerradura izqda. con manivela, pasador y condena. |

acabados / finishes

Rugine (37)